



Karndean  
Designflooring



Beautiful flooring brings a home to life, adding warmth and texture, but choosing beautiful flooring doesn't have to be difficult. At **Karndean Designflooring** we make it easy to find the perfect floor to suit your unique style.





**Karndean**  
Designflooring

# Why Karndean?

Inspired by nature and designed for living, you'll find our floors are beautifully realistic and highly practical.

By offering a wide and impressive range of designs, finishes and formats, you can create a floor that's unique to your home and guaranteed to last for years to come.

## *Did you know?*

Any Karndean floor purchased through one of our retailers comes with a **transferable purchase guarantee**.

So if you move home, the new owner will be covered for the remainder of the product's guarantee period.



*Stylish*



*Quiet*



*Water resistant*



*Realistic*



*Durable*



*Warm underfoot*



*Hygienic*



*Low maintenance*



*Expertise*



## Designflooring: Take a closer look

We find the inspiration for Designflooring in the beauty of the natural world and feel passionate about bringing this into every product we create. From the intricate grain details in real woods to the timeless tactile qualities of natural stones, we've used the latest technology to bring you floors that are the ultimate in style and give you exceptionally high performance and quality. What's more, we've already chosen the best colours, formats and design components for each of our ranges, meaning it's easy to create the perfect design floor for your home.

### *Plank variation*

*Our planks are designed to reflect the variance and random character of natural materials, rather than looking uniform and manufactured.*



### *Wear layer*

*With a protective wear layer on each individual plank and tile, our floors are designed to withstand the everyday hustle and bustle of home life.*



Do you love the authentic, rustic look of traditional crafted wood planks? Or perhaps you prefer the distinctive texture and intricate patterns of quarried stone? Whatever it is you're after, you're sure to find a look that's just right for you in our wide range of stylish, high quality Karndean Designfloors.

### The right look for every room

We know that style is personal and every space is different. To help you find the right floor for your home, see what each of our ranges have to offer:

	Wood	Stone	
Art Select	✓	✓	Lovingly created to reflect the natural materials that inspired them. These planks and stones give you timeless craftsmanship at your feet.
Da Vinci	✓	✓	Smooth slender planks and richly textured tiles. Bevelled edges create distinct definition.
Michelangelo		✓	Make a statement with mosaics, metallics or soft contoured pebbles. Unique and character-packed surfaces.
Van Gogh	✓		The character of real timber in a wide range of designs including distressed, reclaimed and limed woods.
Opus	✓	✓	Fresh and contemporary. Available in larger plank and tile sizes. Simple lines and sleek design combine to create a clean, modern look.
Knight Tile	✓	✓	Our widest range of planks and tiles at our most affordable prices ensures there's something for everyone.
Karndean LooseLay	✓	✓	Quick and easy to fit over most existing hard floors. Quieter than laminate.
Palio Clic	✓	✓	Palio Clic by Karndean is a new type of luxury vinyl flooring with a patented click-locking system. Achieve an authentic and luxurious feel in your space in no time at all.

### Did you know?

All of our products come with a lifetime guarantee of up to 35 years.



# Designflooring: Inspiration

How to create your perfect floor...

We have put together a quick guide to help you design your new floor. Your floor can be as simple or as intricate as you'd like. Follow the steps below to be on your way to creating a floor that's just as unique and individual as you are.

## 1 Choose a main colour and effect

We have an extensive range of colour tones in our **Inspired by Wood**, **Inspired by Stone** collections.

### Inspired by Wood:

Choose from our wide selection of planks, each featuring realistic grain and knot details and textures. We offer a varied range of styles ideal to suit any room in your home.

See **Wood ranges at a glance** on pages 149-151



### Inspired by Stone:

Choose from a palette of natural beiges and browns to cool blues and greens. With tiles including marble, slate, terracotta and ceramic effects plus our Michelangelo range of mosaics, pebbles and metallics.

See **Stone ranges at a glance** on pages 152-153



We offer a wide range of plank and tile sizes. To find out available sizes for your chosen product, please see the individual product pages.

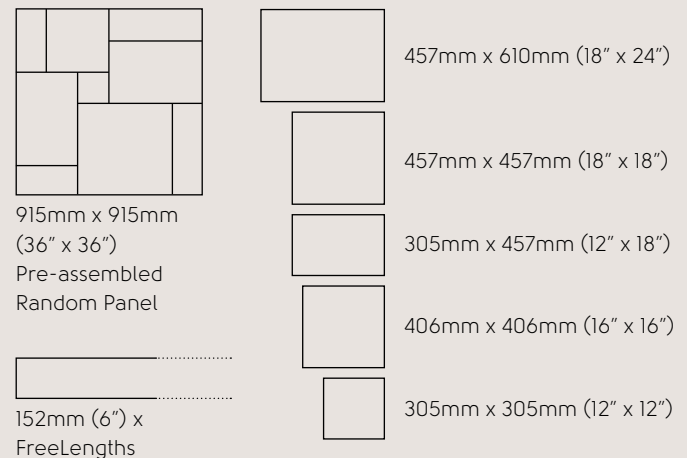
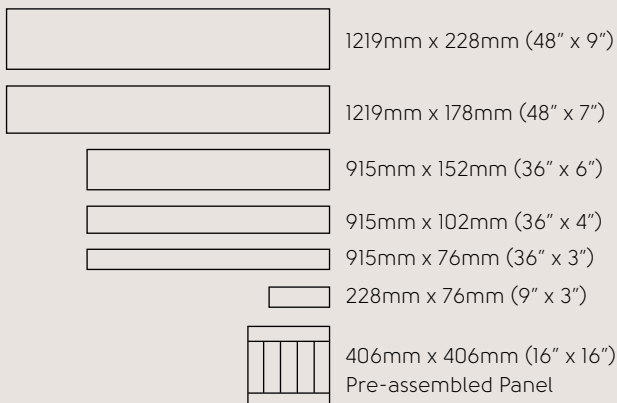



## 2 Add a design strip

Once you have chosen your main floor colour, you have the option of adding a decorative strip...

### Inspired by Wood:

Add a strip between wood planks to create an attractive ship's decking effect.

### Inspired by Stone:

We highly recommend adding a narrow strip to a tile floor to create a natural grouting effect.

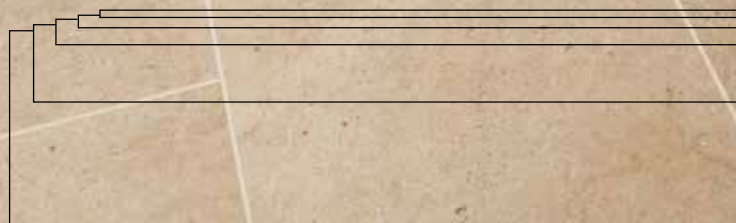

### Grout Strips

Available in two widths:  
3mm and 5mm  
Six colours.  
See page 111

### Design and Metallic Strips

Available in five widths:  
3mm, 5mm, 10mm, 30mm & 76mm  
A wide palette of colours.  
See pages 108-111

*Define your space and  
get creative with strips*

## 3 Add a border

To personalise your floor even further or to help define your space, why not add a border?

### Keyline Borders

Use single strips to define a space.  
See pages 108-111

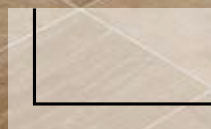

### Tramline Borders

Use a combination of strips to create more emphasis.  
See pages 108-111



### Decorative Borders

Choose from a range of patterned borders designed specifically to complement your chosen floor.  
See pages 112-117

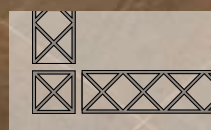

## 4 Add a feature

With seven standard designs to choose from and the ability to design your own, a feature creates a focal point in your room. See pages 118-119







Karndean  
Designflooring

Inspired by  
Wood





Art Select

# Art Select Woods

Full of charm and character, our premium Art Select Wood collection brings the natural beauty of real timber to life in your home.

Through meticulous attention to detail and careful selection of some of the most beautiful and inspiring natural timbers, our Art Select Wood collection includes our most intricate designs and realistic embosses. Each plank is handcrafted to reflect the unique grains, knots and textures of natural wood, but unlike real wood, we're able to design a floor that's not only beautiful and realistic, but is also practical.

Everything that a beautiful wood floor should be, and so much more, each of our Art Select Woods tells its own story.

**Lifetime guarantee:** residential use

Parquet page 15  
Oak Royale page 19  
Oak Premier page 22  
Handcrafted page 25



We've taken classic parquet and crafted a collection that will transform any room in your home with our most detailed and elegant oak designs.



AP01 with P802 3mm and R101 30mm design strips ▾

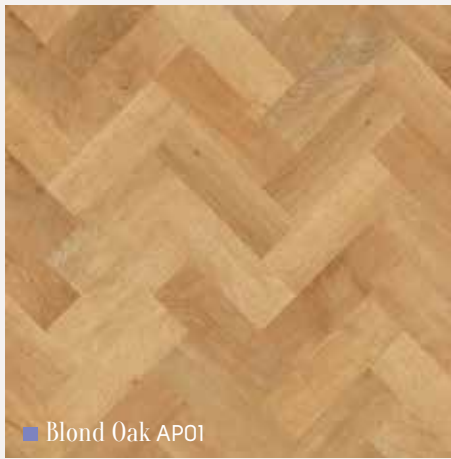

■ Blond Oak AP01

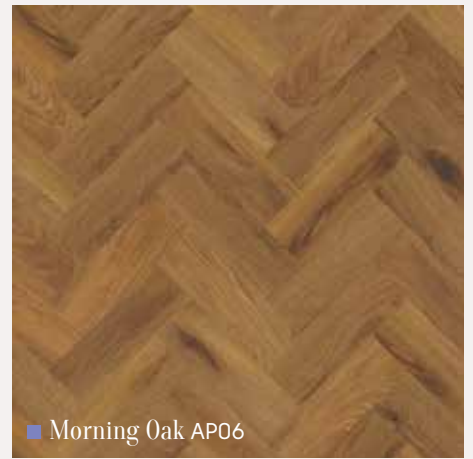

■ Morning Oak AP06

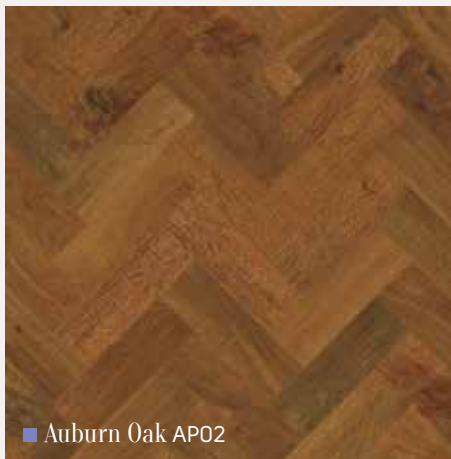

■ Auburn Oak AP02



■ Spanish Cherry AP05



# Art Select Parquet

228mm x 76mm (9" x 3") Please see page 8 for size comparison guide

Find your nearest retailer at [www.karndean.com/FAR](http://www.karndean.com/FAR) or call 01386 820100







AP03 ▽

AP31 ▽



**Herringbone:** Look to the striking diagonals of this design to give a real sense of style in any space.

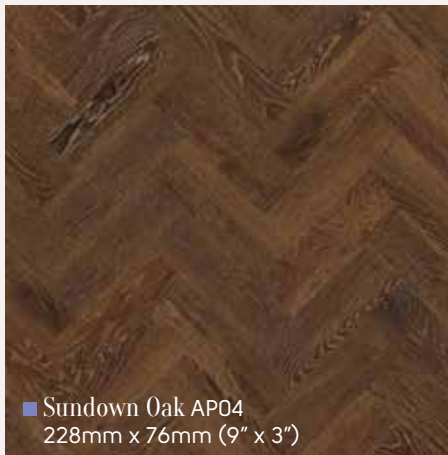

■ Sundown Oak AP04  
228mm x 76mm (9" x 3")

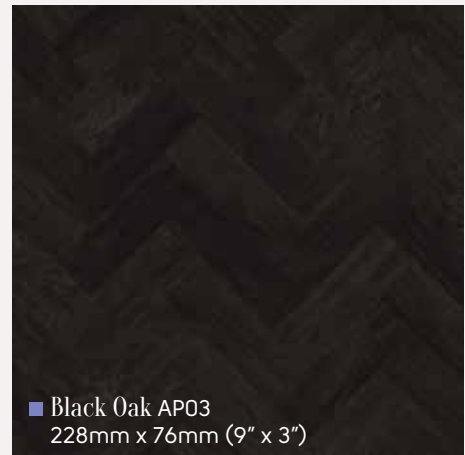

■ Black Oak AP03  
228mm x 76mm (9" x 3")

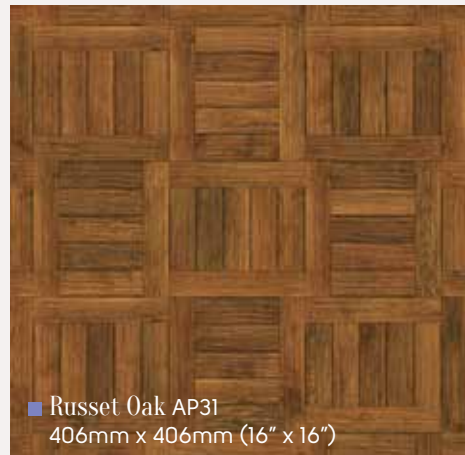

■ Russet Oak AP31  
406mm x 406mm (16" x 16")



# Art Select Parquet

Please see page 8 for size comparison guide

Find your nearest retailer at [www.karndean.com/FAR](http://www.karndean.com/FAR) or call 01386 820100





RL03 ▾



RL02 with DS05 10mm design strip ▾



■ Spring Oak RL01



■ Summer Oak RL02



RL01 with DS05 3mm design strip ▾

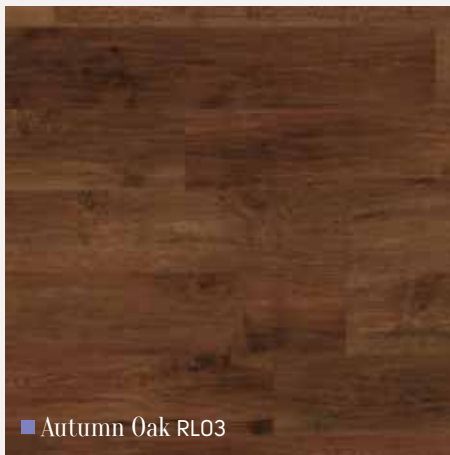

■ Autumn Oak RL03



■ Winter Oak RL04

# Art Select Oak Royale

1219mm x 178mm (48" x 7") Please see page 8 for size comparison guide

Find your nearest retailer at [www.karndean.com/FAR](http://www.karndean.com/FAR) or call 01386 820100







RL07



■ Spanish Cherry RL05



■ Santina Cherry RL07

# Art Select Oak Royale

1219mm x 178mm (48" x 7") Please see page 8 for size comparison guide

Find your nearest retailer at [www.karndean.com/FAR](http://www.karndean.com/FAR) or call 01386 820100



HC02 Δ

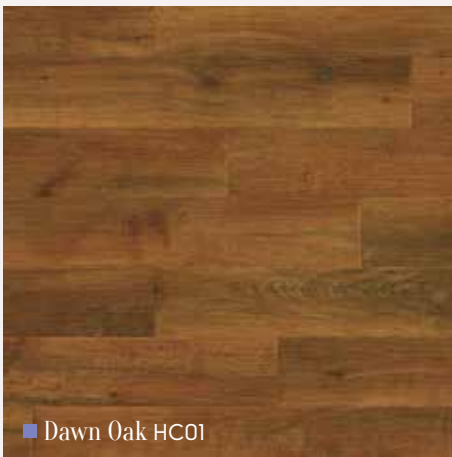

■ Dawn Oak HC01

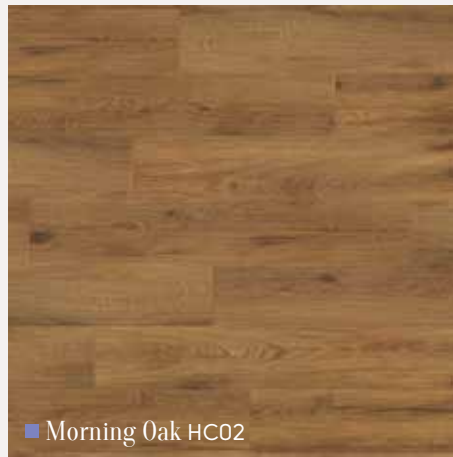

■ Morning Oak HC02



■ Dusk Oak HC03

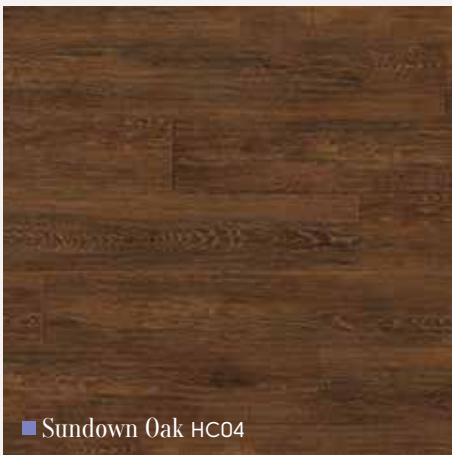

■ Sundown Oak HC04

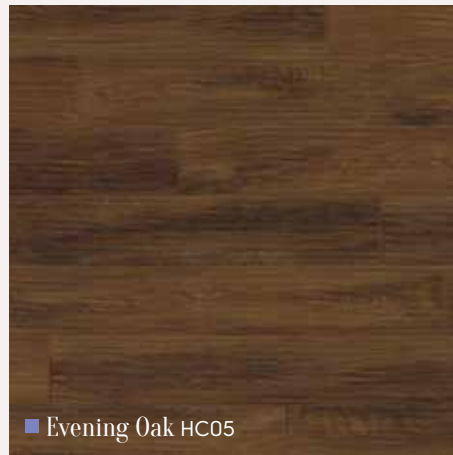

■ Evening Oak HC05



■ Midnight Oak HC06

## Art Select Oak Premier

915mm x 152mm (36" x 6") Please see page 8 for size comparison guide

Find your nearest retailer at [www.karndean.com/FAR](http://www.karndean.com/FAR) or call 01386 820100









EW01 ▽

**Handcrafted:** Designed by hand to perfectly reflect the natural grains, knots and textures of real timber.

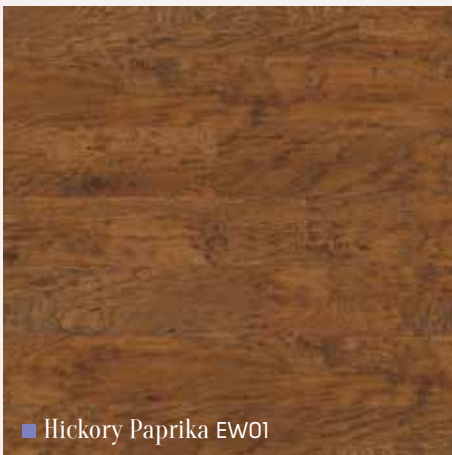

■ Hickory Paprika EW01

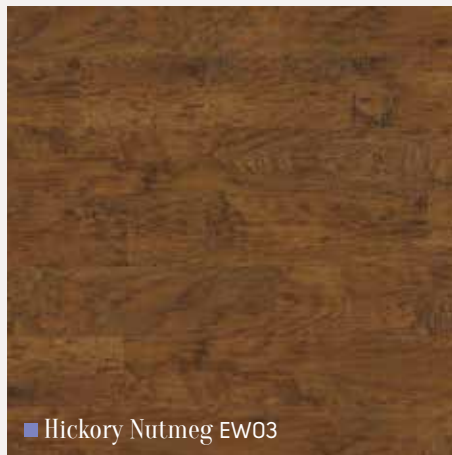

■ Hickory Nutmeg EW03



■ Hickory Peppercorn EW02

# Art Select Handcrafted

915mm x 152mm (36" x 6") Please see page 8 for size comparison guide

Find your nearest retailer at [www.karndean.com/FAR](http://www.karndean.com/FAR) or call 01386 820100





*warm and inviting  
with a classic feel*

RP73 ▲



*Slender 3" planks*

RP102 ▲



*Distinctive bevelling*

RP101 ▲

Da Vinci

# Da Vinci Wood

Lifetime guarantee: residential use

Each of our Da Vinci planks feature a distinctive bevelled edge and light surface finish, creating a traditional look with a modern twist.

With a wide range of colours and designs, from the pale tones of American Oak to the richness of Australian Walnut, there's something to suit any decor.

Light wood page 29

Mid wood page 30

Dark wood page 33





RP103 ▾



■ American Oak RP11

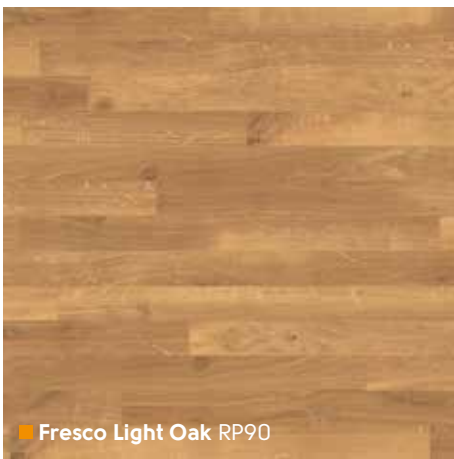

■ Fresco Light Oak RP90

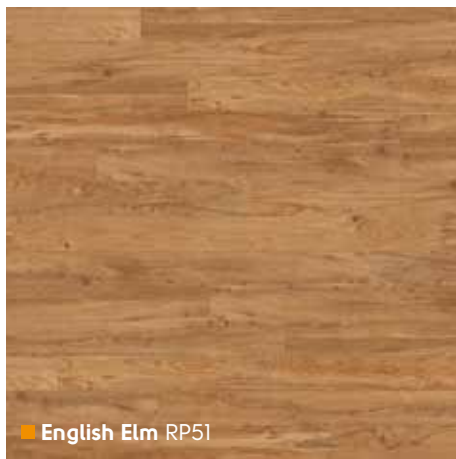

■ English Elm RP51

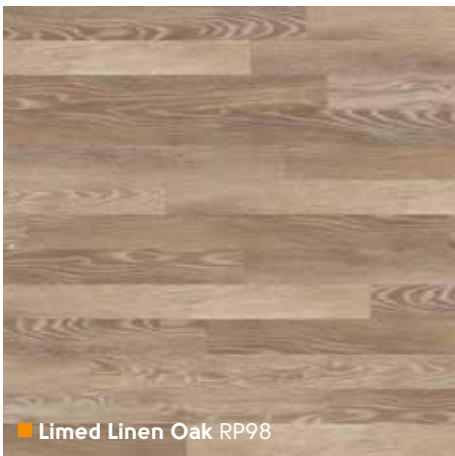

■ Limed Linen Oak RP98

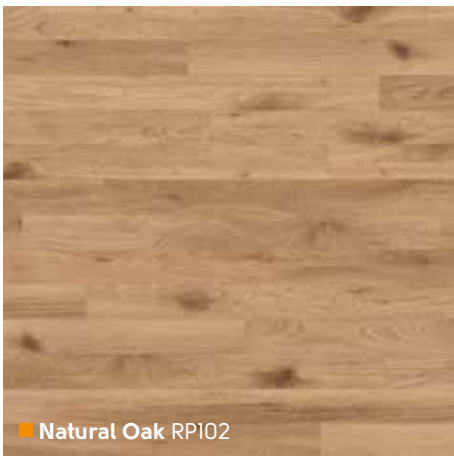

■ Natural Oak RP102

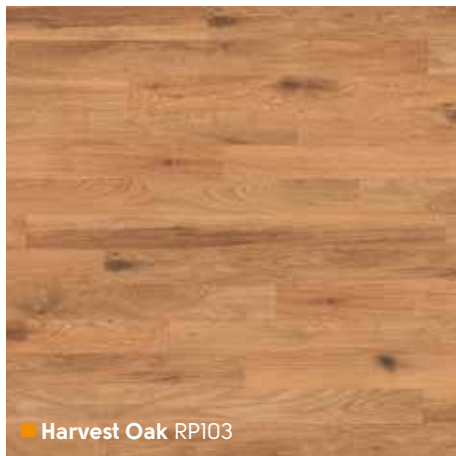

■ Harvest Oak RP103

# Da Vinci Light Wood

915mm x 76mm (36" x 3") Please see page 8 for size comparison guide

Find your nearest retailer at [www.karndean.com/FAR](http://www.karndean.com/FAR) or call 01386 820100

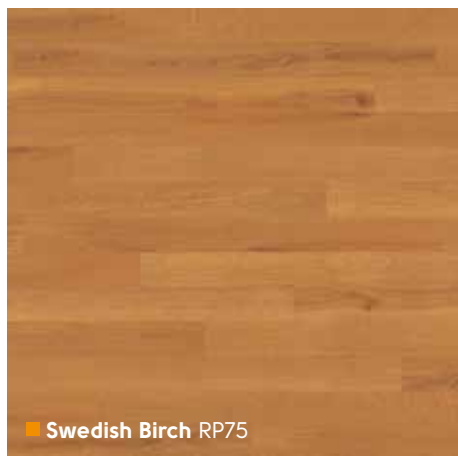

■ Swedish Birch RP75



RP73 ▲

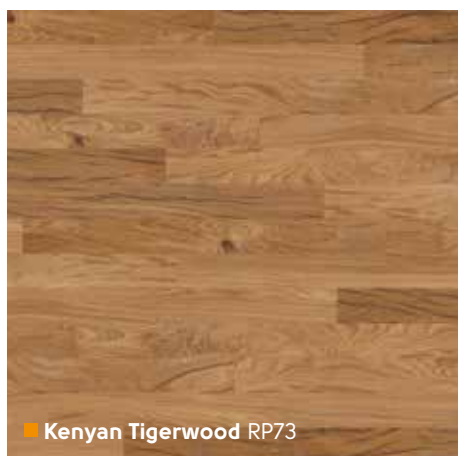

■ Kenyan Tigerwood RP73

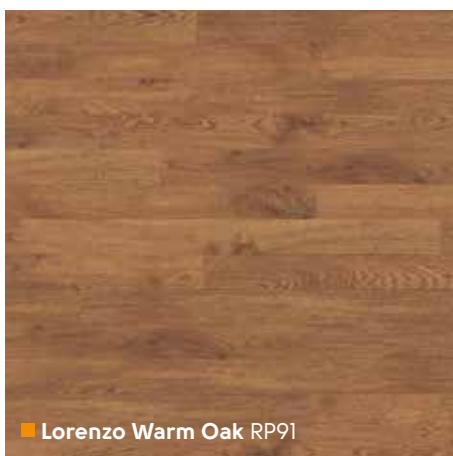

■ Lorenzo Warm Oak RP91

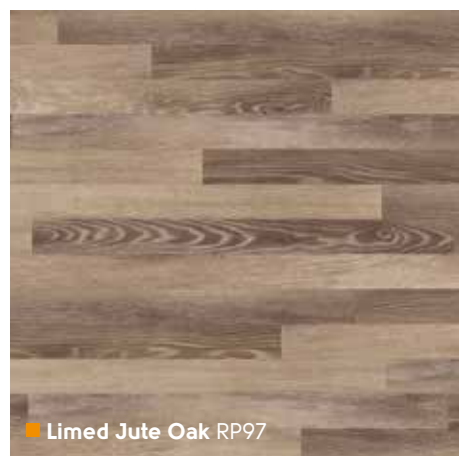

■ Limed Jute Oak RP97

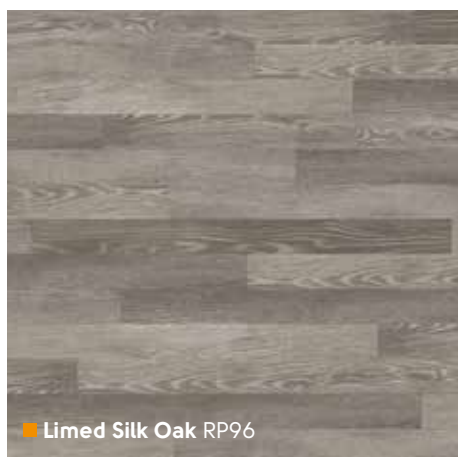

■ Limed Silk Oak RP96

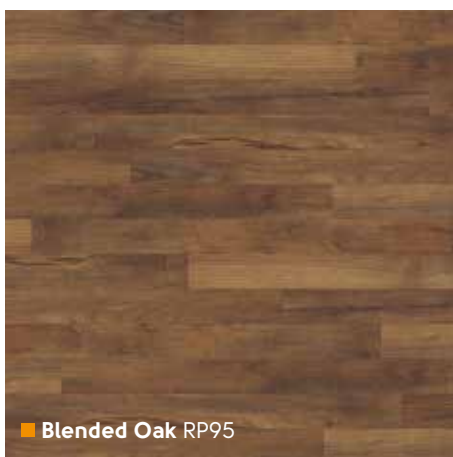

■ Blended Oak RP95

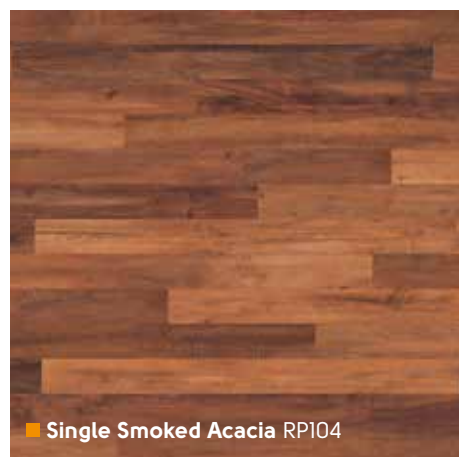

■ Single Smoked Acacia RP104

# Da Vinci Mid Wood

915mm x 76mm (36" x 3") Please see page 8 for size comparison guide

Find your nearest retailer at [www.karndean.com/FAR](http://www.karndean.com/FAR) or call 01386 820100







RP41 with Block border ▾



*Add a decorative border for an individual look, See page 112 for more inspiration*

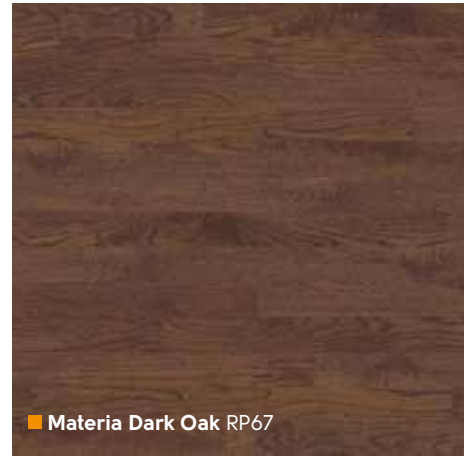

■ **Materia Dark Oak** RP67

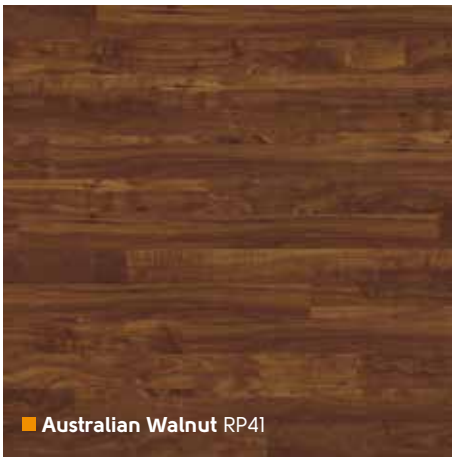

■ **Australian Walnut** RP41

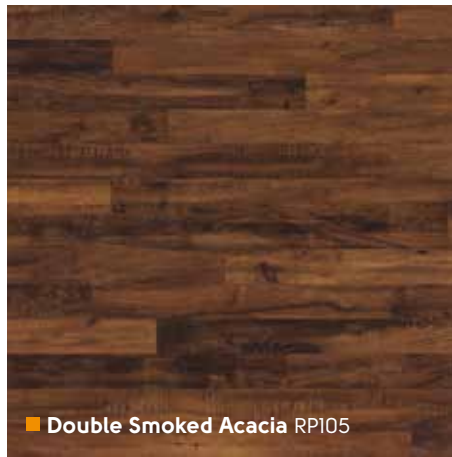

■ **Double Smoked Acacia** RP105



■ **Scorched Oak** RP94



■ **Beach Driftwood** RP101

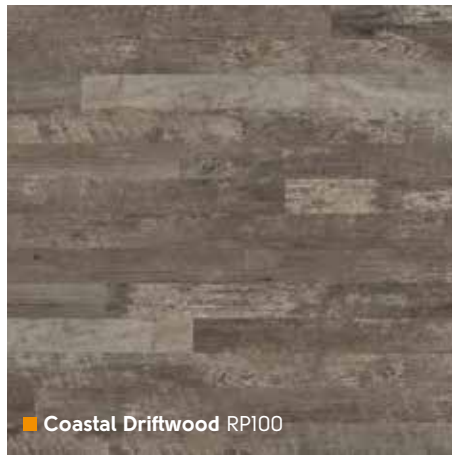

■ **Coastal Driftwood** RP100

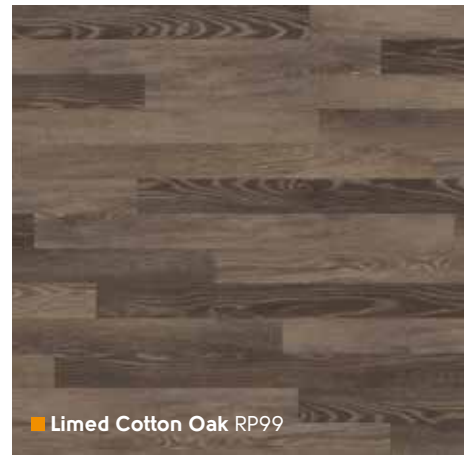

■ **Limed Cotton Oak** RP99



# Da Vinci Dark Wood

915mm x 76mm (36" x 3") Please see page 8 for size comparison guide

Find your nearest retailer at [www.karndean.com/FAR](http://www.karndean.com/FAR) or call 01386 820100





*warm and inviting*

VCW861 with DS03 3mm design strip Δ



*Subtle texture*

VCW871 Δ



*Large planks*

VCW841 Δ

Van Gogh

# Van Gogh Wood

Lifetime guarantee: residential use

Our popular Van Gogh collection captures the look of real timber in a variety of colours and designs from traditional rustic to cool contemporary. Large planks, distinctive grain details and a subtle texture create a style that works in any space.

Light wood page 37

Mid wood page 39

Dark wood page 43

*Change the angle of your  
planks to create open plan  
spaces with definition*





VGW84T ▽

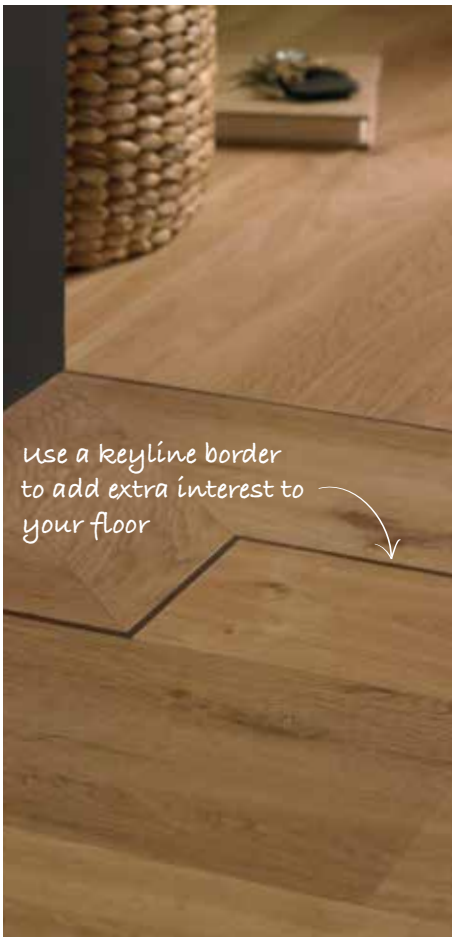

*Use a keyline border to add extra interest to your floor*



VGW85T with DS05 10mm design strip ▽

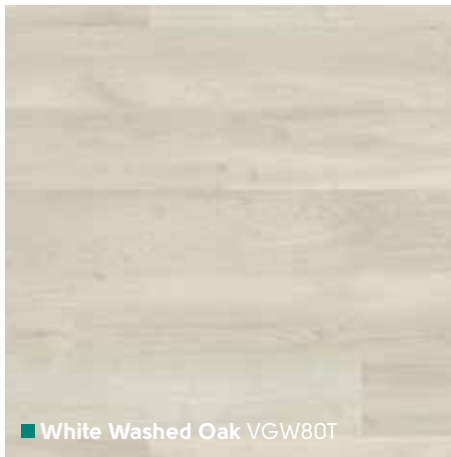

■ White Washed Oak VGW80T



■ Birch VGW84T

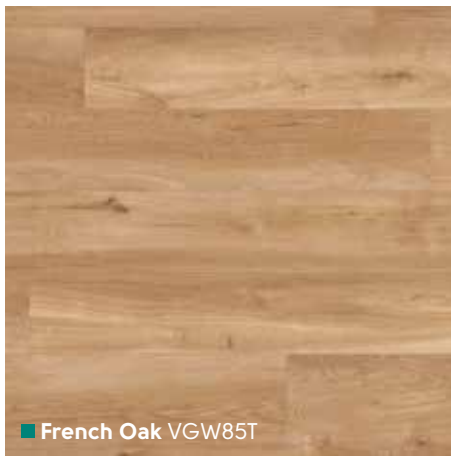

■ French Oak VGW85T



■ Macrocapra VGW50T

# Van Gogh Light Wood

1219mm x 178mm (48" x 7") Please see page 8 for size comparison guide

Find your nearest retailer at [www.karndean.com/FAR](http://www.karndean.com/FAR) or call 01386 820100





VGW8IT ▾

Blue and purple hues are a perfect match for our rustic Country Oak planks

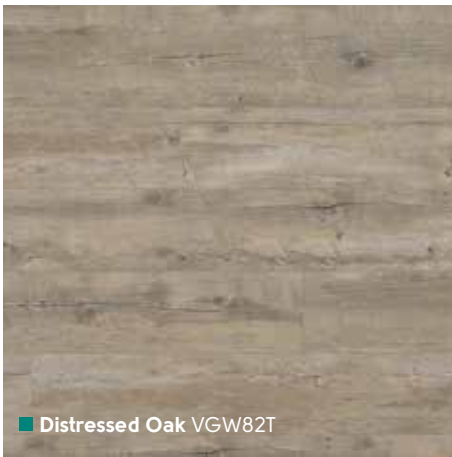

■ Distressed Oak VGW82T

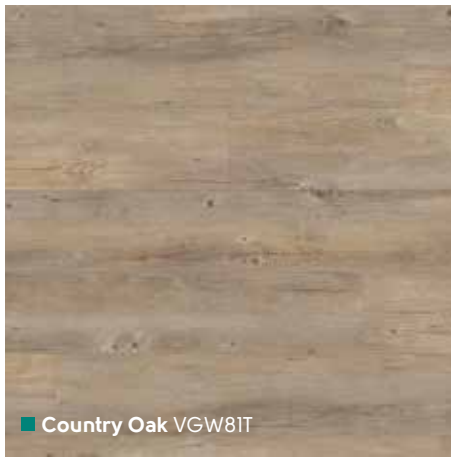

■ Country Oak VGW8IT

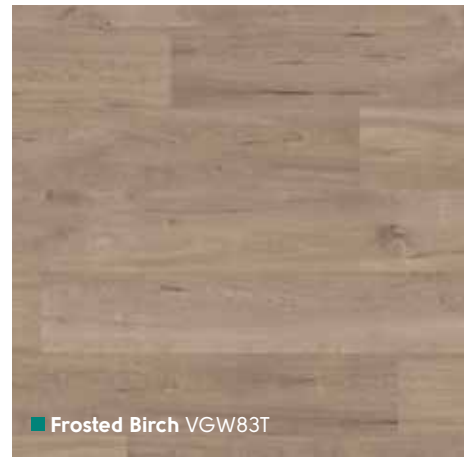

■ Frosted Birch VGW83T



■ Auckland Oak VGW52T

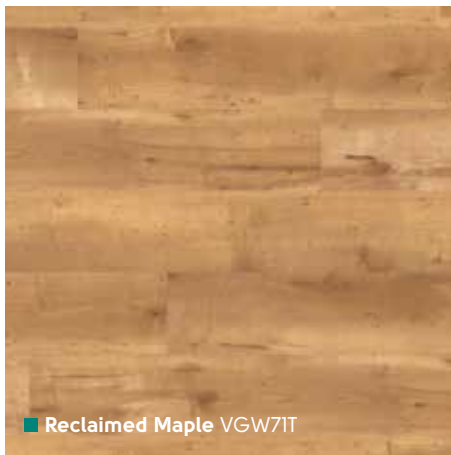

■ Reclaimed Maple VGW7IT



■ Wellington Oak VGW53T

# Van Gogh Mid Wood

1219mm x 178mm (48" x 7") Please see page 8 for size comparison guide

Find your nearest retailer at [www.karndean.com/FAR](http://www.karndean.com/FAR) or call 01386 820100



VG5-7 ▽

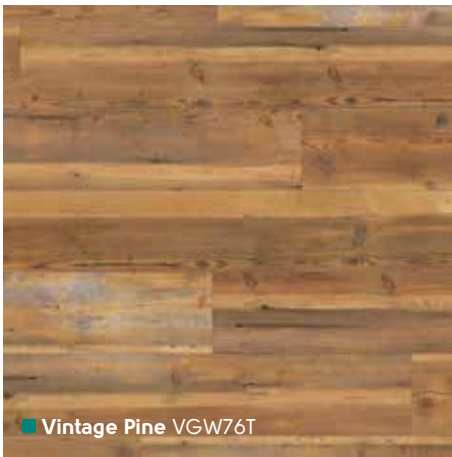

■ Vintage Pine VGW76T

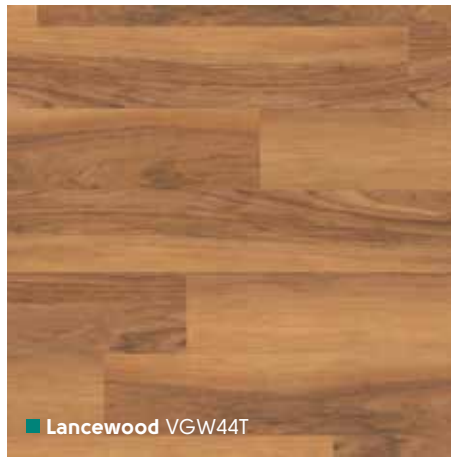

■ Lancewood VGW44T

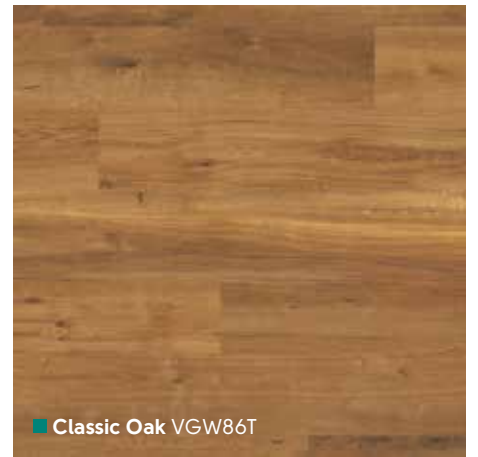

■ Classic Oak VGW86T

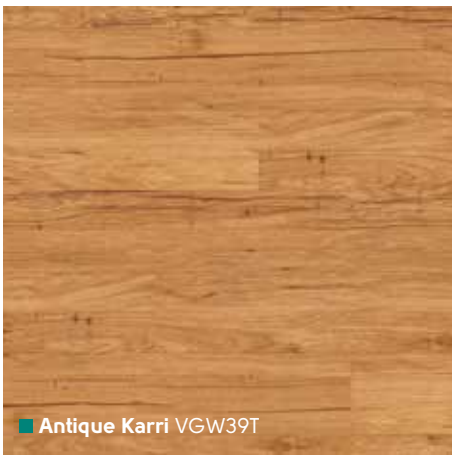

■ Antique Karri VGW39T

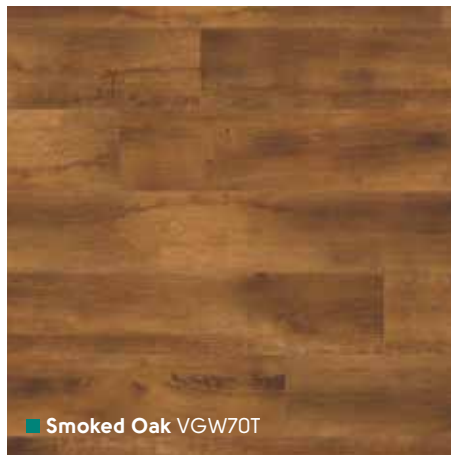

■ Smoked Oak VGW70T

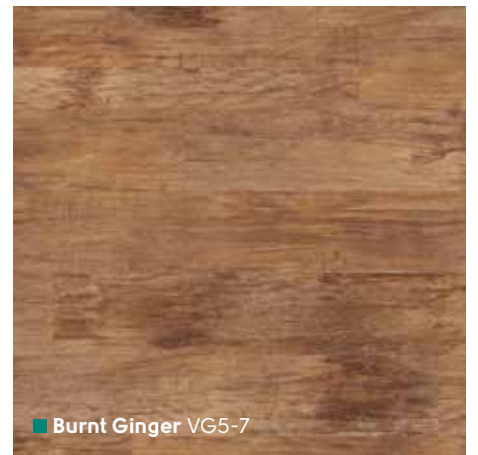

■ Burnt Ginger VG5-7

# Van Gogh Mid Wood

1219mm x 178mm (48" x 7") Please see page 8 for size comparison guide

Find your nearest retailer at [www.karndean.com/FAR](http://www.karndean.com/FAR) or call 01386 820100





BOCKER  
GLORY  
SHEAD & BUTTER PUDDING





VGW87T with DS06 3mm design strip ▽



Dark woods can give a sophisticated feel

VGW89T ▽

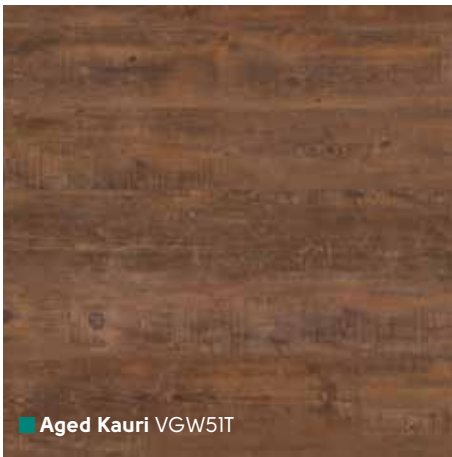

■ Aged Kauri VGW51T



■ Christchurch Oak VGW54T



■ Bracken VG1-7



■ Walnut VGW87T

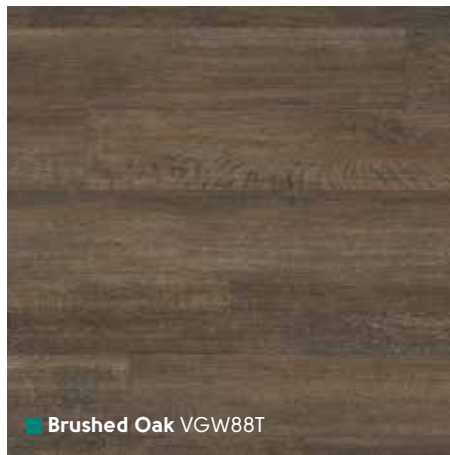

■ Brushed Oak VGW88T

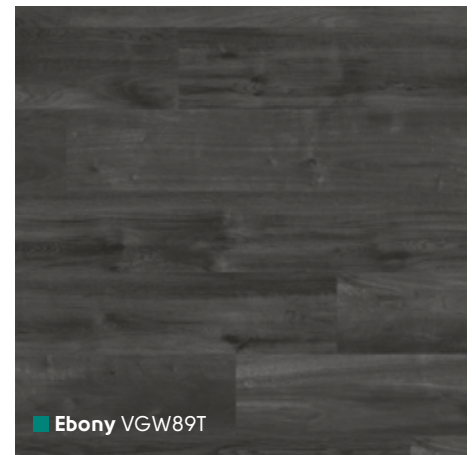

■ Ebony VGW89T

# Van Gogh Dark Wood

1219mm x 178mm (48" x 7") Please see page 8 for size comparison guide

Find your nearest retailer at [www.karndean.com/FAR](http://www.karndean.com/FAR) or call 01386 820100





Fresh and  
contemporary

WP311 Δ



Mix of surface finishes

WP313 Δ



Large plank sizes

WP414 Δ

Opus

# Opus Wood

Lifetime guarantee: residential use

Our Opus collection brings you a fresh, modern feel in some of our largest plank sizes. The wide range of tones and mix of surface finishes combined with clean lines means you can achieve a sense of simplicity and visual space whatever your colour scheme.

Light wood page 47

Mid wood page 48

Dark wood page 51





WP311 ▾

Create an airy, contemporary look by teaming cool light woods with vibrant colours



WP411 ▾



■ Palleo WP312  
915mm x 152mm (36" x 6")

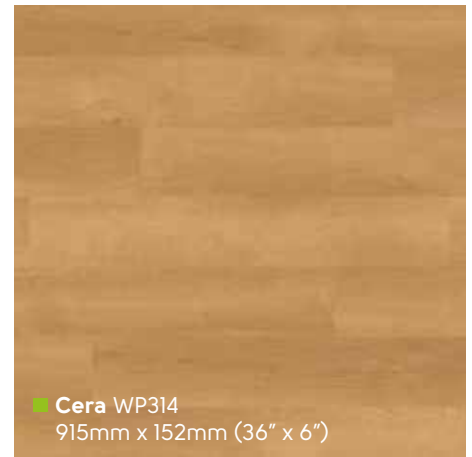

■ Cera WP314  
915mm x 152mm (36" x 6")



■ Grano WP311  
915mm x 152mm (36" x 6")



■ Niveus WP411  
1219mm x 228mm (48" x 9")

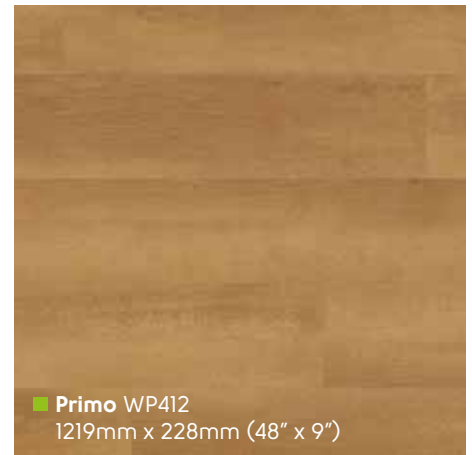

■ Primo WP412  
1219mm x 228mm (48" x 9")

# Opus Light Wood

Please see page 8 for size comparison guide

Find your nearest retailer at [www.karndean.com/FAR](http://www.karndean.com/FAR) or call 01386 820100

WP313 with DSD6 3mm design strip ▾



*The character of aged timber can really add to any style of room*

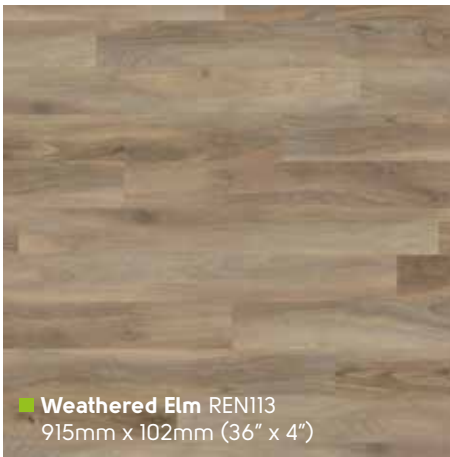

■ **Weathered Elm** REN113  
915mm x 102mm (36" x 4")

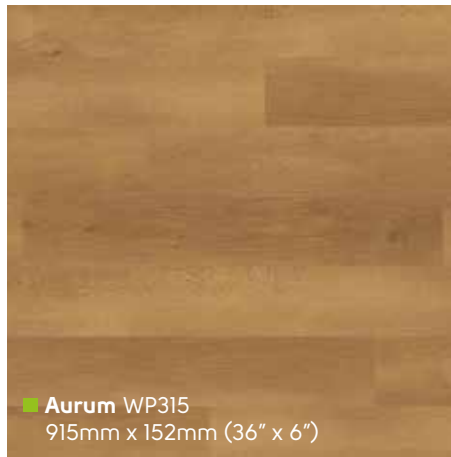

■ **Aurum** WP315  
915mm x 152mm (36" x 6")

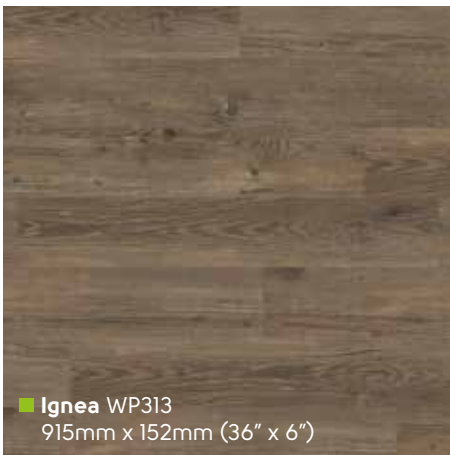

■ **Ignea** WP313  
915mm x 152mm (36" x 6")

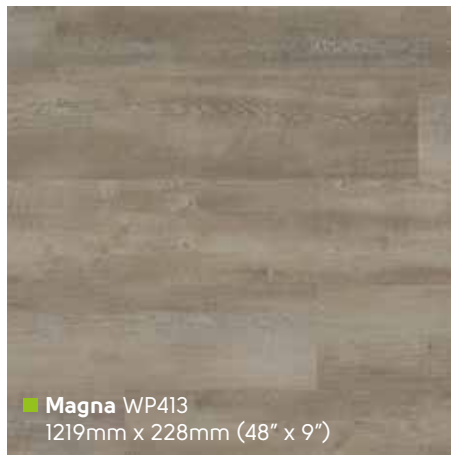

■ **Magna** WP413  
1219mm x 228mm (48" x 9")

# Opus Mid Wood

Please see page 8 for size comparison guide

Find your nearest retailer at [www.karndean.com/FAR](http://www.karndean.com/FAR) or call 01386 820100











WP414 with DS17 and AF01 3mm design strips ▽



Add a simple and smart tranline border to create a sophisticated look

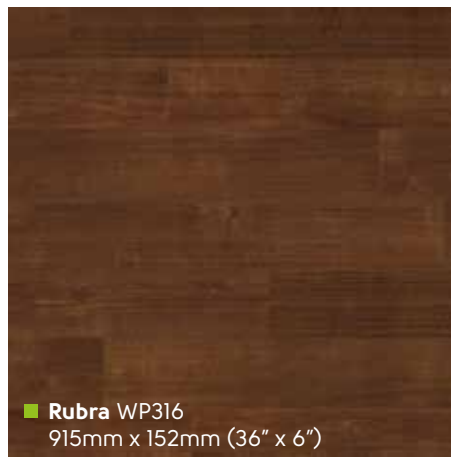

■ **Rubra** WP316  
915mm x 152mm (36" x 6")

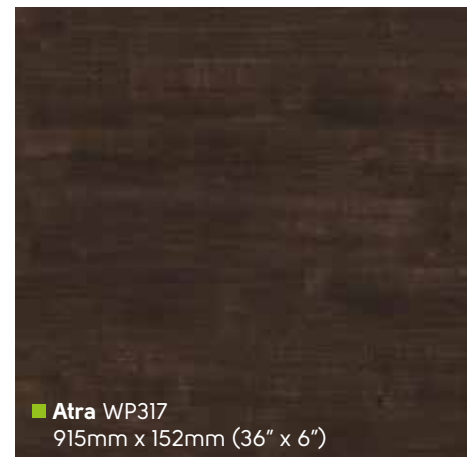

■ **Atra** WP317  
915mm x 152mm (36" x 6")

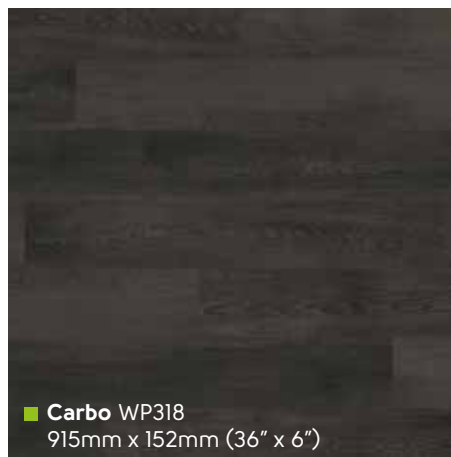

■ **Carbo** WP318  
915mm x 152mm (36" x 6")

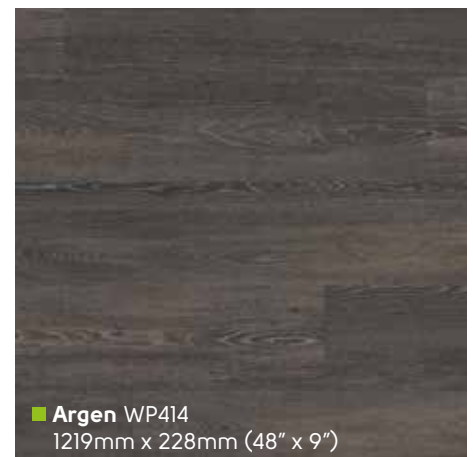

■ **Argen** WP414  
1219mm x 228mm (48" x 9")

# Opus Dark Wood

Please see page 8 for size comparison guide

Find your nearest retailer at [www.karndean.com/FAR](http://www.karndean.com/FAR) or call 01386 820100





*Wide selection*

KP94 Δ



*Works wonderfully  
throughout your home*

KP91 Δ



*Knot and grain detail  
on every plank*

KP92 with DS02 10mm design strip Δ

**Knight Tile**

# Knight Tile Wood

**Lifetime guarantee:** residential use

Our Knight Tile woods collection offers our widest range of planks at our most affordable prices, ensuring there's something for everyone. Choose from a variety of design strips and borders to personalise your space.

Light wood page 55

Mid wood page 56

Dark wood page 61





KP94 ▽



KP94 with DS06 3mm design strip ▽



■ **White Painted Oak** KP105  
915mm x 152mm (36" x 6")

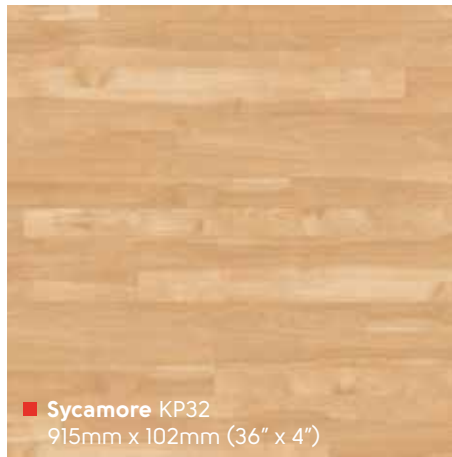

■ **Sycamore** KP32  
915mm x 102mm (36" x 4")

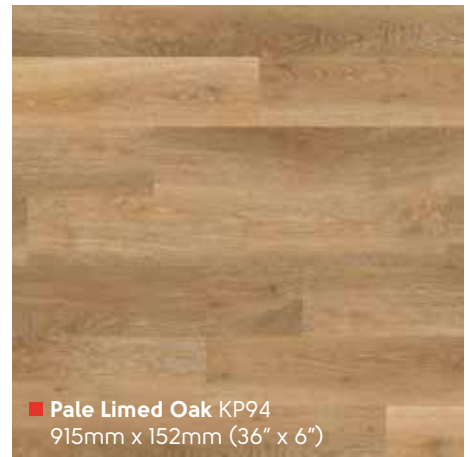

■ **Pale Limed Oak** KP94  
915mm x 152mm (36" x 6")



■ **Arctic Driftwood** KP51  
915mm x 102mm (36" x 4")

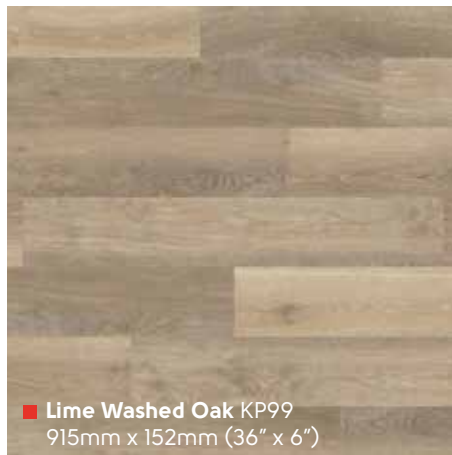

■ **Lime Washed Oak** KP99  
915mm x 152mm (36" x 6")

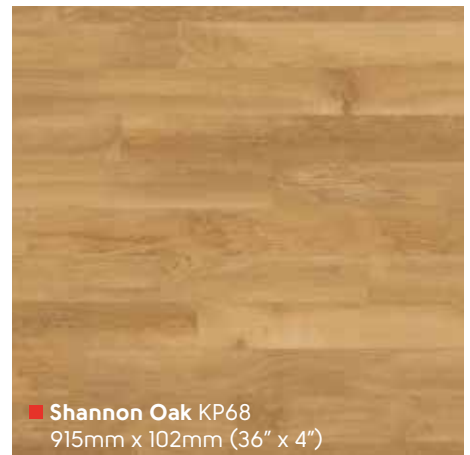

■ **Shannon Oak** KP68  
915mm x 102mm (36" x 4")

# Knight Tile Light Wood

Please see page 8 for size comparison guide

Find your nearest retailer at [www.karndean.com/FAR](http://www.karndean.com/FAR) or call 01386 820100

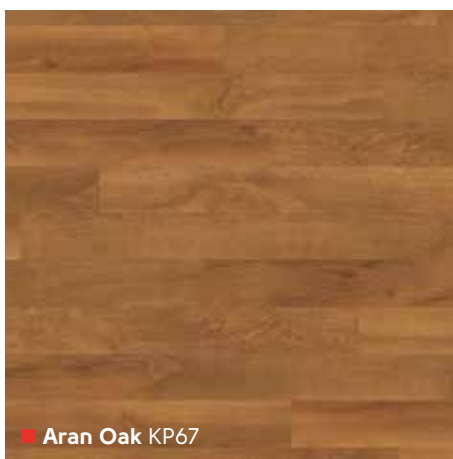
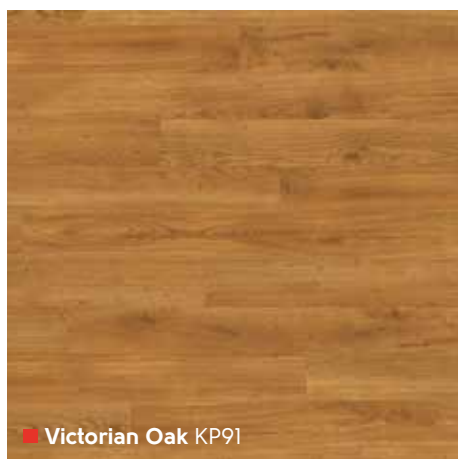
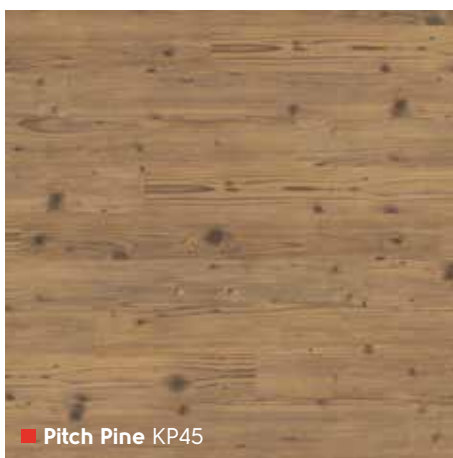
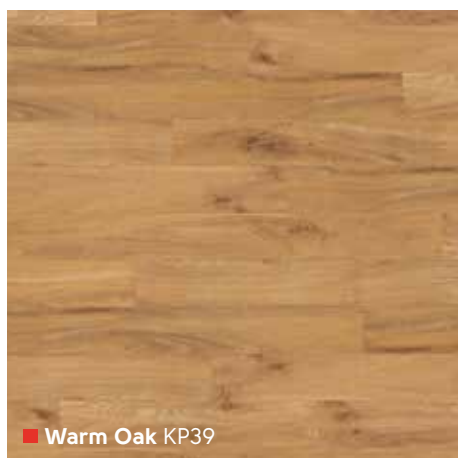

## Knight Tile Mid Wood

915mm x 102mm (36" x 4") Please see page 8 for size comparison guide

Find your nearest retailer at [www.karndean.com/FAR](http://www.karndean.com/FAR) or call 01386 820100









Mid-toned woods and white walls work well as a neutral base to showcase your personal style



*Go for chalky pastels and vintage accessories to give your space a trendy retro chic look*

KP96 ▽



▽ KP102

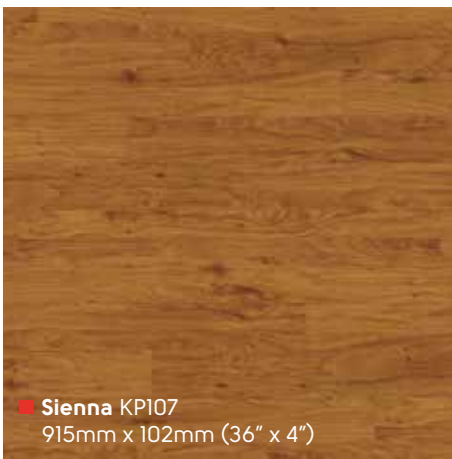

■ **Sienna KP107**  
915mm x 102mm (36" x 4")

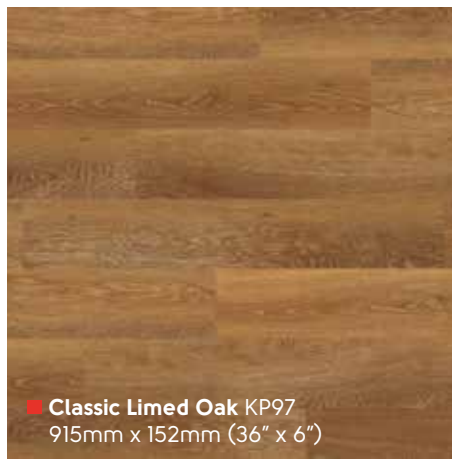

■ **Classic Limed Oak KP97**  
915mm x 152mm (36" x 6")

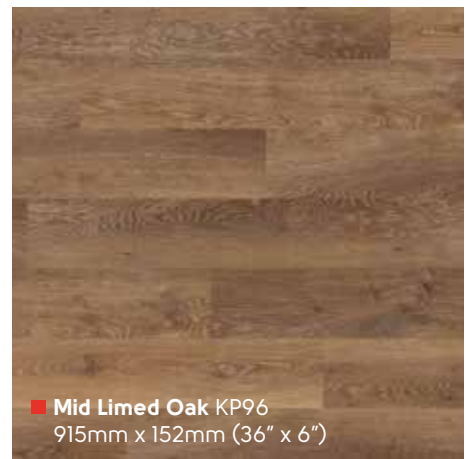

■ **Mid Limed Oak KP96**  
915mm x 152mm (36" x 6")

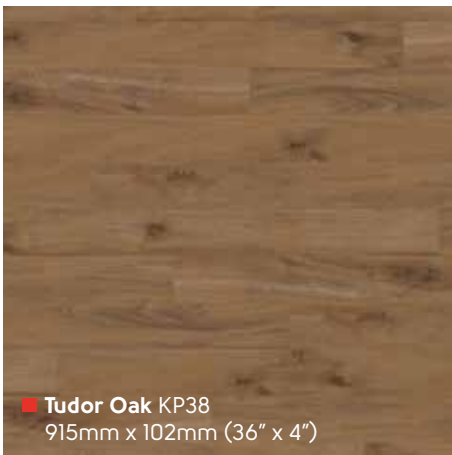

■ **Tudor Oak KP38**  
915mm x 102mm (36" x 4")

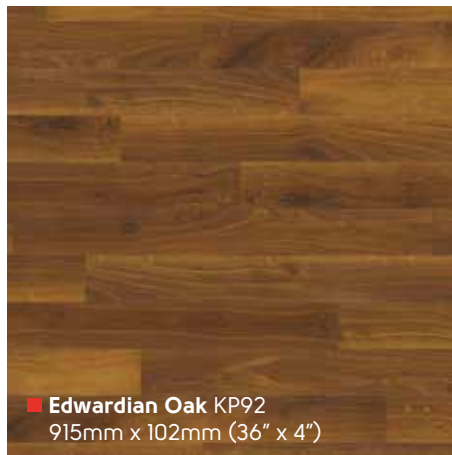

■ **Edwardian Oak KP92**  
915mm x 102mm (36" x 4")



■ **Mid Brushed Oak KP102**  
915mm x 152mm (36" x 6")

# Knight Tile Mid Wood

Please see page 8 for size comparison guide

Find your nearest retailer at [www.karndean.com/FAR](http://www.karndean.com/FAR) or call 01386 820100





Separate each row of planks with design strips for a ship's decking effect

KP103 with DS05 3mm design strip ▾



■ Caribbean Driftwood KP52  
915mm x 102mm (36" x 4")



■ Mid Worn Oak KP103  
915mm x 152mm (36" x 6")



■ Native Koa KP93  
915mm x 102mm (36" x 4")



KP98 ▾

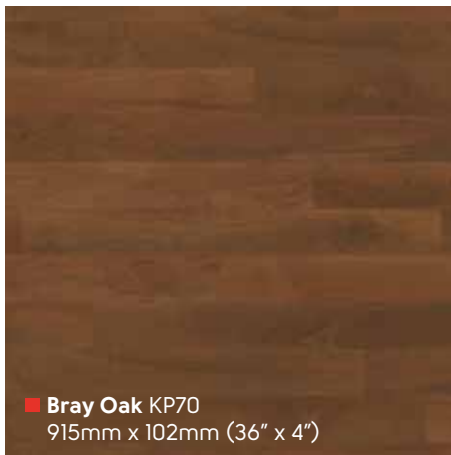

■ Bray Oak KP70  
915mm x 102mm (36" x 4")

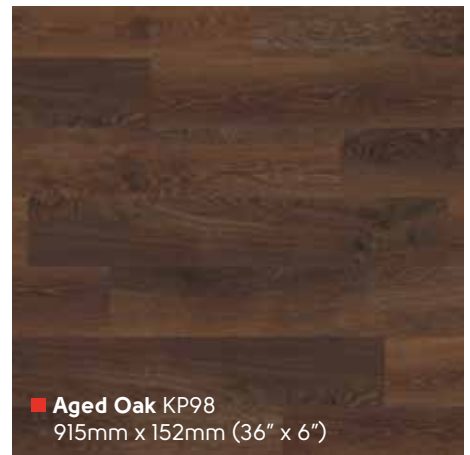

■ Aged Oak KP98  
915mm x 152mm (36" x 6")

# Knight Tile Dark Wood

Please see page 8 for size comparison guide

Find your nearest retailer at [www.karndean.com/FAR](http://www.karndean.com/FAR) or call 01386 820100





Inspired by  
Stone







Art Select

# Art Select Stones

Effortlessly stylish and one of a kind, our premium Art Select Stone collection brings the natural beauty of travertine, slate, marble and limestone to life in your home.

Expect our most authentic designs and realistic embosses, handcrafted to reflect the unique patterns and textures of real stone.

Precious and individual, each of our Art Select Stones tells its own story.

**Lifetime guarantee:** residential use

Travertine page 67

Slate page 70

Marble page 73

Limestone page 75





**FreeLengths:** Available in the same decadent tones as our full tiles, these stones are each six inches wide, but in varying lengths.

LM17 with DS10 3mm design strip ▾



■ Washburn LM07  
with DS10 3mm design strip  
457mm x 610mm (18" x 24")



■ Washburn LM17  
152mm (6") x FreeLengths

LM07 and LM17 with DS10 3mm design strip ▾

# Art Select Travertine

Our FreeLength stones are 6" wide in varying lengths. Please see page 8 for size comparison guide

Find your nearest retailer at [www.karndean.com/FAR](http://www.karndean.com/FAR) or call 01386 820100



For a truly unique look, lay our full size travertine tiles running into FreeLengths to create a stunning 'room to room' design.



LM09 with DS15 3mm design strip ▾



LM08 with DS13 3mm design strip ▾



■ Caldera LM08  
with DS13 3mm design strip  
457mm x 610mm (18" x 24")



■ Gallatin LM09  
with DS15 3mm design strip  
457mm x 610mm (18" x 24")



■ Caldera LM18  
152mm (6") x FreeLengths



■ Gallatin LM19  
152mm (6") x FreeLengths

# Art Select Travertine

Our FreeLength stones are 6" wide in varying lengths. Please see page 8 for size comparison guide

Find your nearest retailer at [www.karndean.com/FAR](http://www.karndean.com/FAR) or call 01386 820100

Each of our designs have been handcrafted to perfectly reflect the unique patterns and intricate textures of real stone.

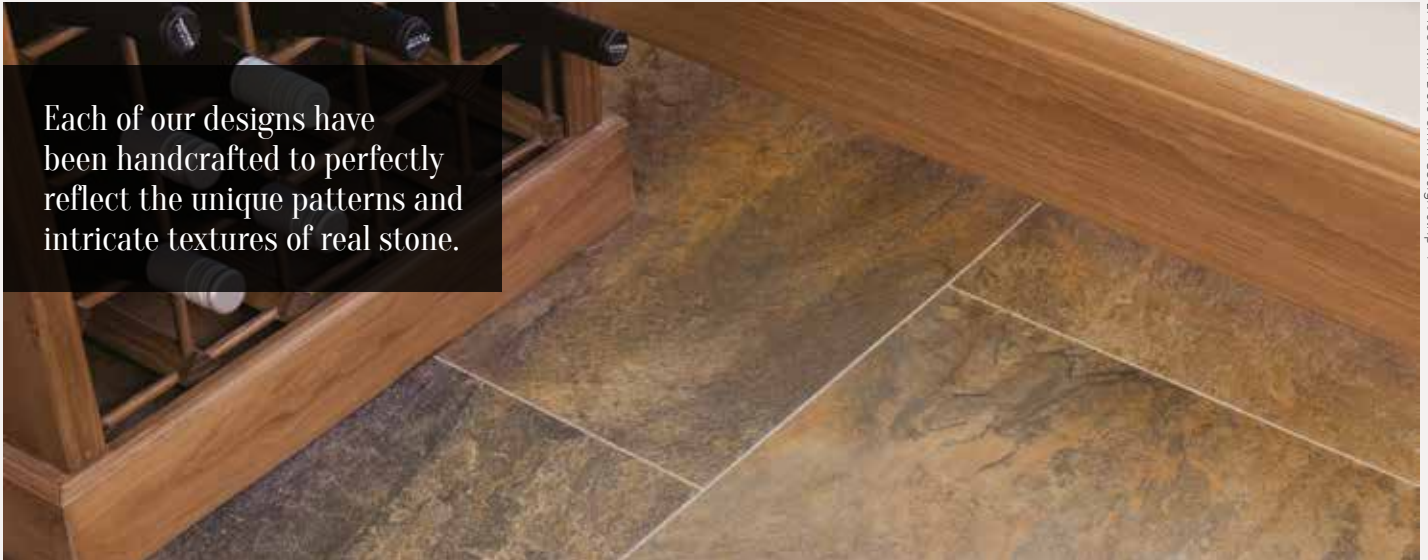

Welsh Slates



Parliament Slates

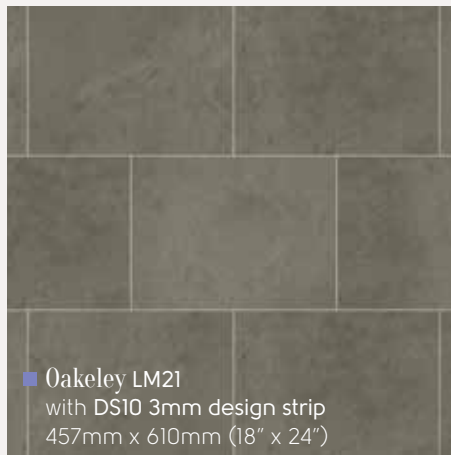
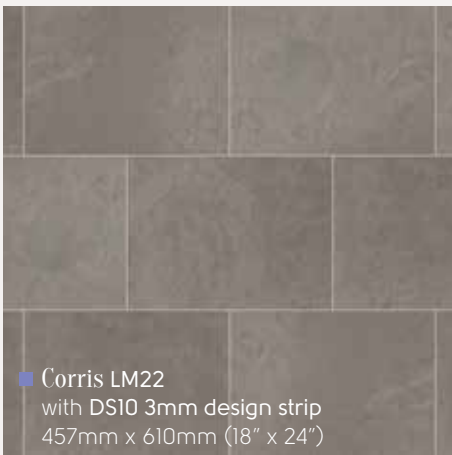

# Art Select Slate

\*A pre-assembled panel of 9 assorted tiles with design strip and offsetting tiles to create a random look  
Please see page 8 for size comparison guide

Find your nearest retailer at [www.karndean.com/FAR](http://www.karndean.com/FAR) or call 01386 820100



■ Canberra LM06 with DS15 3mm design strip







**Clipped Corners:** Both 'Otono' and 'Fiore' are available in 'clipped corner' designs. Lay together with complementary key squares to achieve a traditional Italian marble look.

LM15-Clip ▽

Italian Marbles

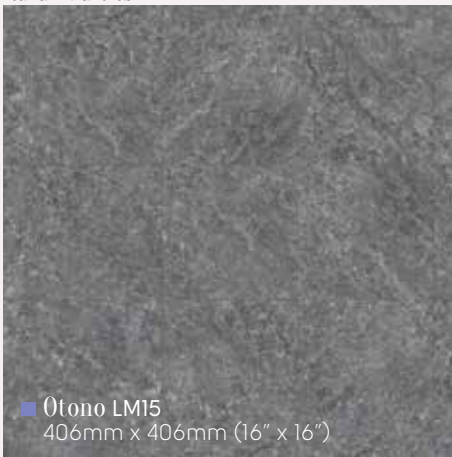

■ Otono LM15  
406mm x 406mm (16" x 16")



■ Fiore LM16  
406mm x 406mm (16" x 16")

Ashford Marble

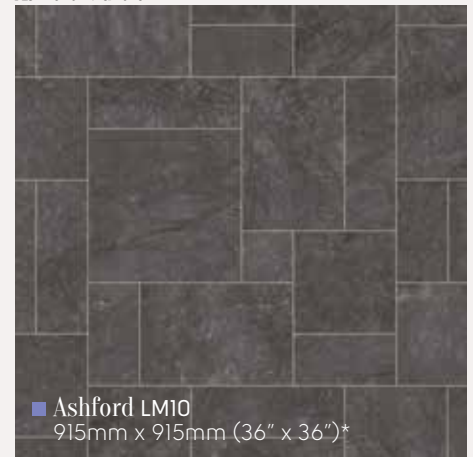

■ Ashford LM10  
915mm x 915mm (36" x 36")\*



■ Otono LM15-Clip  
406mm x 406mm (16" x 16")



■ Fiore LM16-Clip  
406mm x 406mm (16" x 16")



LM16 ▽

# Art Select Marble

\*A pre-assembled panel of 9 assorted tiles with design strip and offsetting tiles to create a random look  
Please see page 8 for size comparison guide

Find your nearest retailer at [www.karndean.com/FAR](http://www.karndean.com/FAR) or call 01386 820100





LM201



■ Alderney LM03



■ Jersey LM01



■ Guernsey LM02



■ Herm LM20

# Art Select Limestone

915mm x 915mm (36" x 36")\* Please see page 8 for size comparison guide

\*A pre-assembled panel of 9 assorted tiles with design strip and offsetting tiles to create a random look

Find your nearest retailer at [www.karndean.com/FAR](http://www.karndean.com/FAR) or call 01386 820100







*Distinctive bevelling*

CK25 with AF05 5mm grout strip ▲

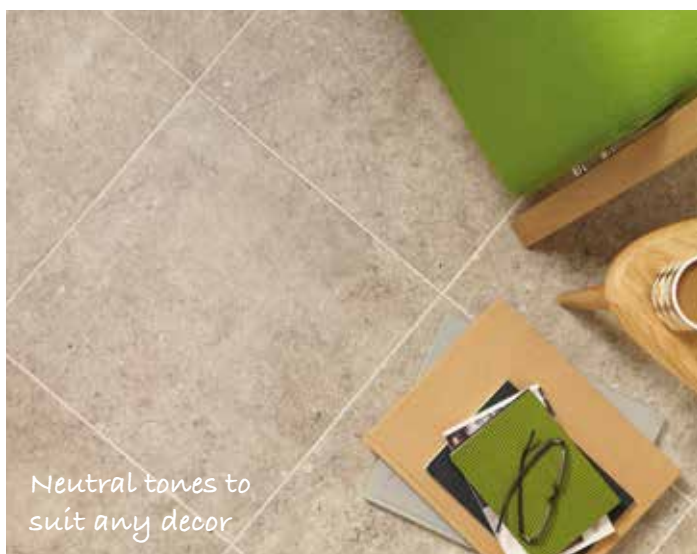

*Neutral tones to suit any decor*

LST04 with DS10 3mm design strip ▲



*Design elements to complement your floor*

LST05 with REN34 3mm design strip and Canterbury border ▲

Da Vinci

# Da Vinci Stone

Lifetime guarantee: residential use

Our Da Vinci collection offers the rich textures of natural stone, slate and ceramic, with a comforting warmth unique to Karndean Designflooring. The angled edges add definition to each tile and a range of design strips enables you to choose a finishing touch to complete your look.

Light stone page 79

Mid stone page 82

Dark stone page 85





LST03 with DS13 5mm design strip ▽



LST02 with AF06 3mm ▽

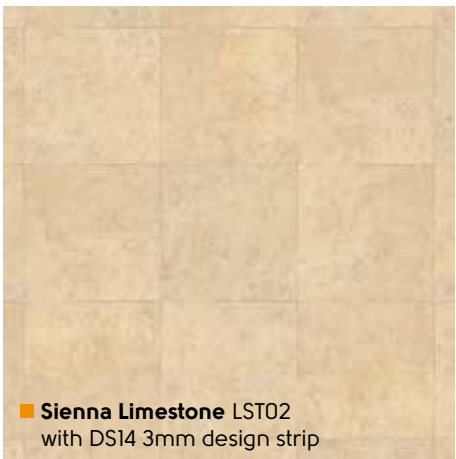

■ Sienna Limestone LST02 with DS14 3mm design strip



LST03 with DS13 5mm design strip ▽

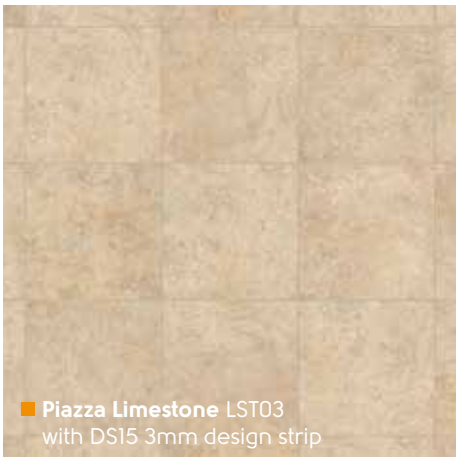

■ Piazza Limestone LST03 with DS15 3mm design strip



■ Spirito Limestone LST04 with DS16 3mm design strip

# Da Vinci Light Stone

406mm x 406mm (16" x 16") Please see page 8 for size comparison guide

Find your nearest retailer at [www.karndean.com/FAR](http://www.karndean.com/FAR) or call 01386 820100

Our wide range of decorative borders can help you personalise your space

CK24 with DS13 5mm design strip and Inca border ▽



LST05 with REN34 3mm design strip ▽

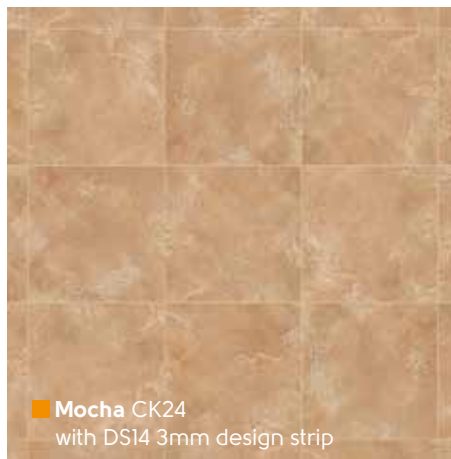

■ Mocha CK24  
with DS14 3mm design strip



■ Santi Limestone LST05  
with DS10 3mm design strip



# Da Vinci Mid Stone

406mm x 406mm (16" x 16") Please see page 8 for size comparison guide

Find your nearest retailer at [www.karndean.com/FAR](http://www.karndean.com/FAR) or call 01386 820100









CC06 with DS18 3mm design strip ▽



Pair dark stone tiles with bright, bold pops of colour for a modern look



CK25 with DS18 3mm design strip and Basque border ▽

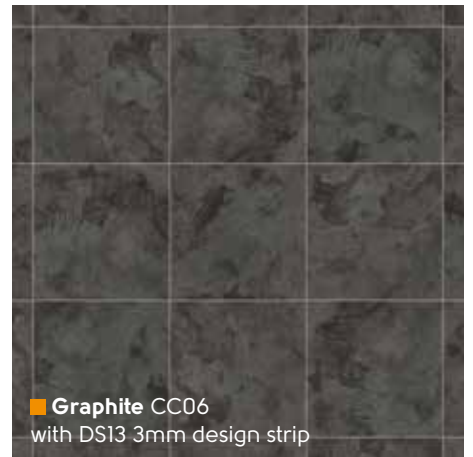

■ Graphite CC06 with DS13 3mm design strip



■ Noir CK25 with DS13 3mm design strip



# Da Vinci Dark Stone

406mm x 406mm (16" x 16") Please see page 8 for size comparison guide

Find your nearest retailer at [www.karndean.com/FAR](http://www.karndean.com/FAR) or call 01386 820100





Mosaics

MX92 Δ



Pebbles

MS2 Δ



Metallics

MLC08 with DS18 3mm design strip Δ

Michelangelo

# Michelangelo Stone

Lifetime guarantee: residential use

Our Michelangelo collection contains some of our most unique designs. The soft contours of our Pebble and the contemporary Metallic effects use some of our most advanced techniques of registered embossing.

You can create a truly unique look by using Mosaic, Pebble and Metallic effect tiles, available in a variety of colours.

Mosaics page 87

Pebbles page 88

Metallics page 91





MX92 with Cube border ▾

*Our pebble and mosaic floors are ideal for bathrooms*



■ Ancient Onyx MX95



■ Venetian Blue MX97



■ Neopolitan Brick MX93



MX92 ▾



■ Adriatic Blue MX98



■ Umbrian Nero MX92

# Michelangelo Mosaic

305mm x 305mm (12" x 12") Please see page 8 for size comparison guide

Find your nearest retailer at [www.karndean.com/FAR](http://www.karndean.com/FAR) or call 01386 820100



MS5 ▽

*Andalucian Opal comes in this pretty pattern of pebble tiles with wide design strips*



MS3 ▽



■ Andalucian Opal MS5

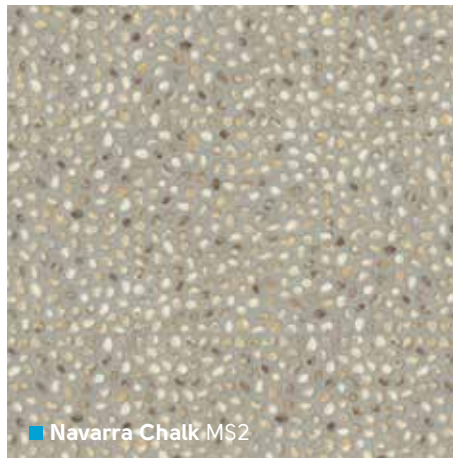

■ Navarra Chalk MS2

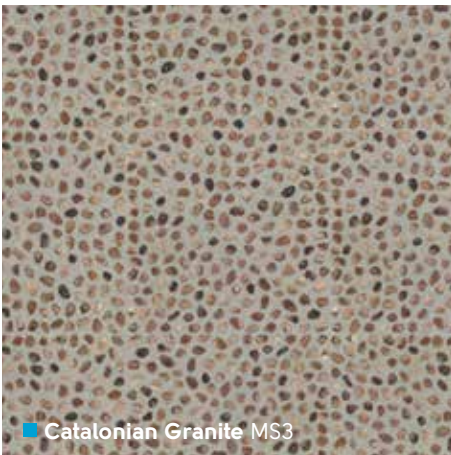

■ Catalonian Granite MS3

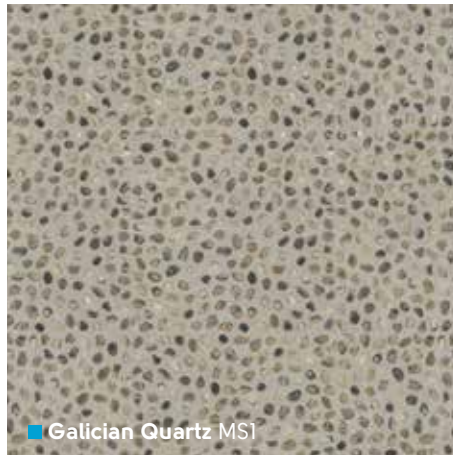

■ Galician Quartz MS1

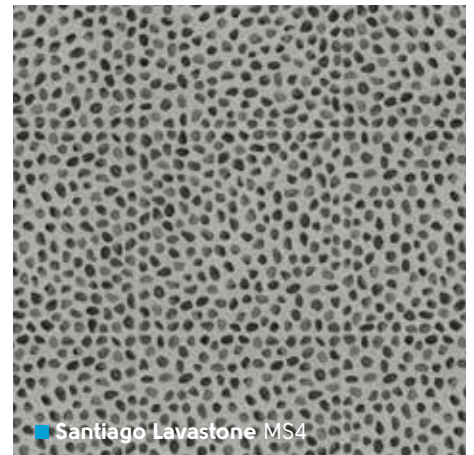

■ Santiago Lavastone MS4

# Michelangelo Pebble

305mm x 305mm (12" x 12") Please see page 8 for size comparison guide

Find your nearest retailer at [www.karndean.com/FAR](http://www.karndean.com/FAR) or call 01386 820100









MLC08 ▽

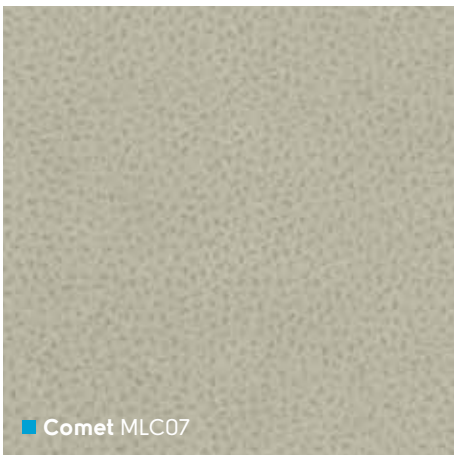

■ Comet MLC07

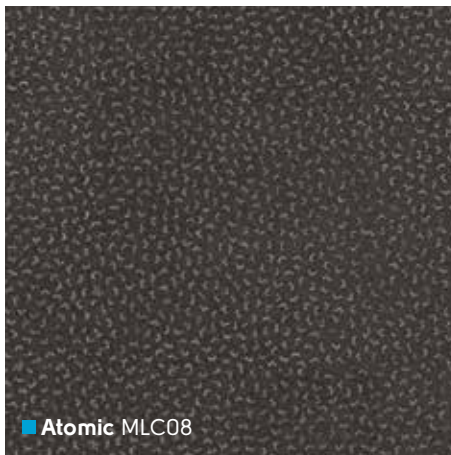

■ Atomic MLC08



■ Tungsten MLC01

# Michelangelo Metallic

406mm x 406mm (16" x 16") Please see page 8 for size comparison guide

Find your nearest retailer at [www.karndean.com/FAR](http://www.karndean.com/FAR) or call 01386 820100





*Larger tiles*

SP212 with AF04 3mm design strip Δ



*Smooth surface finish*

SP213 & SP115 with DS10 3mm design strip Δ



*Contemporary designs*

SP215 with DS17 3mm design strip Δ

Opus

# Opus Stone

Lifetime guarantee: residential use

Our Opus collection includes a range of contemporary stone effects available in some of our largest tile sizes. The smoother surface and range of colours create a really clean, modern look to suit most spaces. Add complementary design strips between tiles for a realistic grout effect.

Light stone page 94

Mid stone page 97

Dark stone page 98

SP111 with AF05 3mm design strip ▽



*Lighten up your space  
with stylish pale tones*



■ **Luna** SP111  
with AF04 3mm design strip  
457mm x 457mm (18" x 18")



■ **Solis** SP112  
with AF04 3mm design strip  
457mm x 457mm (18" x 18")



■ **Terra** SP212  
with AF05 3mm design strip  
457mm x 610mm (18" x 24")

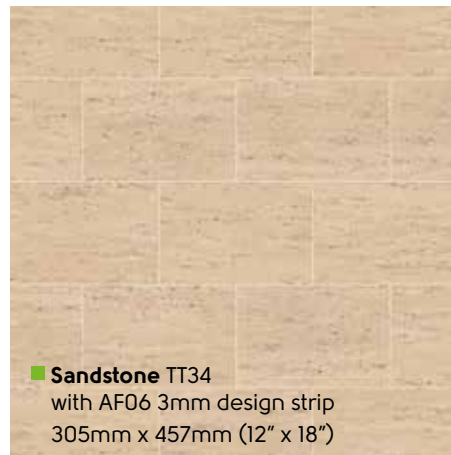

■ **Sandstone** TT34  
with AF06 3mm design strip  
305mm x 457mm (12" x 18")

# Opus Light Stone

Please see page 8 for size comparison guide

Find your nearest retailer at [www.karndean.com/FAR](http://www.karndean.com/FAR) or call 01386 820100



■ Terra SP212 with AF04 3mm design strip





SP211 with AF05 and AF01 3mm design strip ▾



SP213 with AF05 3mm design strip ▾



SP211 with AF05 3mm design strip ▾



■ **Nimbus** SP113  
with AF06 3mm design strip  
457mm x 457mm (18" x 18")



■ **Mico** SP211  
with AF06 3mm design strip  
457mm x 610mm (18" x 24")

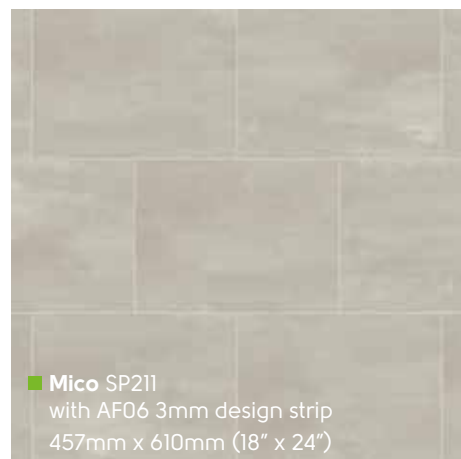

■ **Urbus** SP213  
with AF05 3mm design strip  
457mm x 610mm (18" x 24")



■ **Forma** SP214  
with AF02 3mm design strip  
457mm x 610mm (18" x 24")

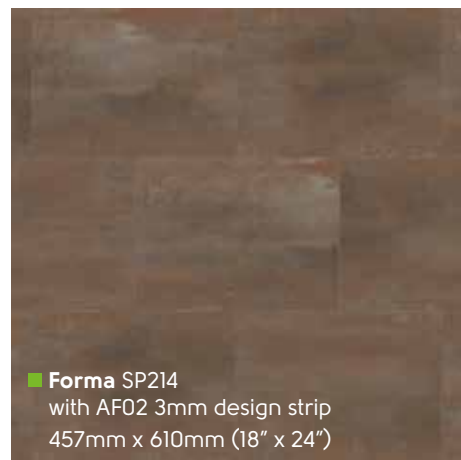

# Opus Mid Stone

Please see page 8 for size comparison guide

Find your nearest retailer at [www.karndean.com/FAR](http://www.karndean.com/FAR) or call 01386 820100



REN21 ▽

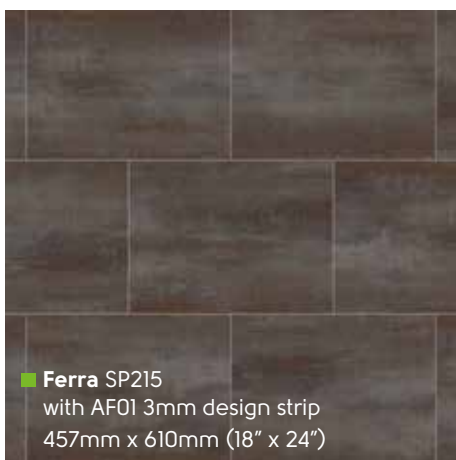

■ **Ferra SP215**  
with AF01 3mm design strip  
457mm x 610mm (18" x 24")



■ **Ombra SP114**  
with AF06 3mm design strip  
457mm x 457mm (18" x 18")

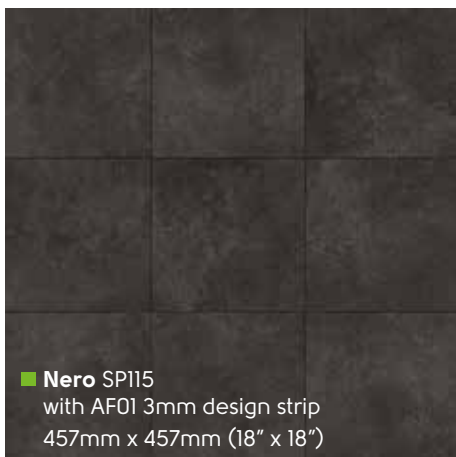

■ **Nero SP115**  
with AF01 3mm design strip  
457mm x 457mm (18" x 18")



■ **Atlantic Slate REN21**  
915mm x 915mm (36" x 36")\*

# Opus Dark Stone

\*A pre-assembled panel of 9 assorted tiles with design strip and offsetting tiles to create a random look  
Please see page 8 for size comparison guide

Find your nearest retailer at [www.karndean.com/FAR](http://www.karndean.com/FAR) or call 01386 820100









*Widest selection*

T99 with DS16 3mm design strip Δ



*Lightly textured surface*

ST14 with DS10 3mm design strip Δ



*Easy to personalise*

T101 with DS14 3mm design strip and Portobello border Δ

**Knight Tile**

# Knight Tile Stone

**Lifetime guarantee:** residential use

In our Knight Tile collection, you'll find a great selection of effects and styles to suit your needs, at our most affordable prices. Each colour and design reflects a wide range of natural materials from classic pale to contemporary dark stones for any space in your home.

Light stone page 102

Mid stone page 105

Dark stone page 107

ST10 with DS16 3mm design strip ▽



*Stylish pale tones can add light to your space*

T98 with DS15 3mm design strip ▽



■ Carrara T90



■ Balin Stone ST8  
with DS14 3mm design strip



■ Cara T98  
with DS14 3mm design strip



■ Linton Stone ST9  
with DS14 3mm design strip



■ Damas Stone ST10  
with DS16 3mm design strip



■ Soapstone ST5  
with DS14 3mm design strip

# Knight Tile Light Stone

305mm x 305mm (12" x 12") Please see page 8 for size comparison guide

Find your nearest retailer at [www.karndean.com/FAR](http://www.karndean.com/FAR) or call 01386 820100







ST13 with DS10 3mm design strip and Light Mackintosh border ▽



*Try adding a border to define your room*

ST11 with DS10 3mm design strip and Light Mosaic border ▽

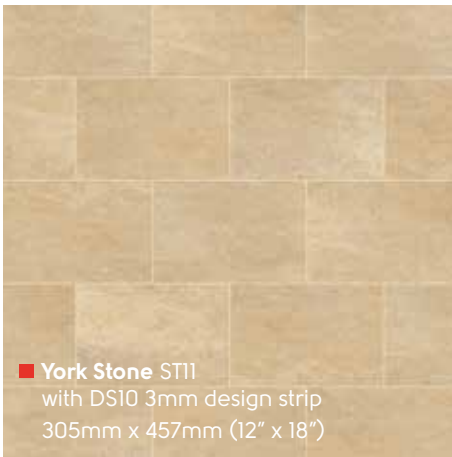

■ **York Stone ST11**  
with DS10 3mm design strip  
305mm x 457mm (12" x 18")

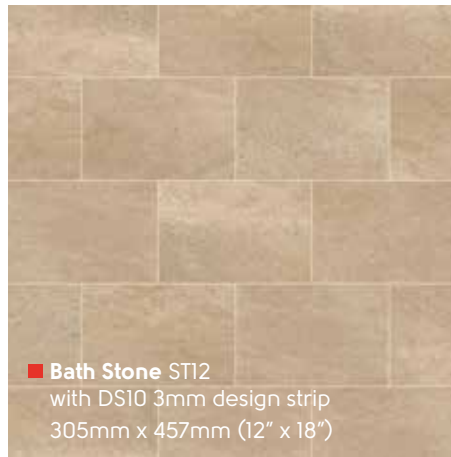

■ **Bath Stone ST12**  
with DS10 3mm design strip  
305mm x 457mm (12" x 18")



■ **Portland Stone ST13**  
with DS10 3mm design strip  
305mm x 457mm (12" x 18")

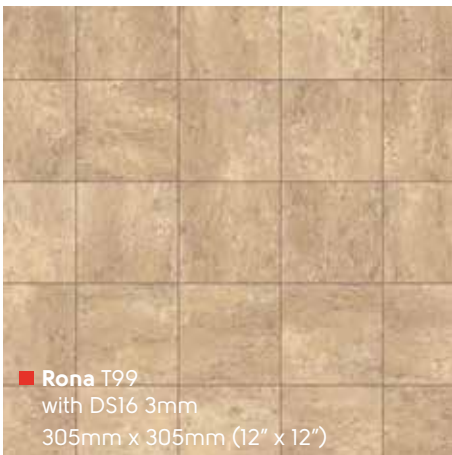

■ **Rona T99**  
with DS16 3mm  
305mm x 305mm (12" x 12")



■ **Andecite T89**  
with DS14 3mm  
305mm x 305mm (12" x 12")

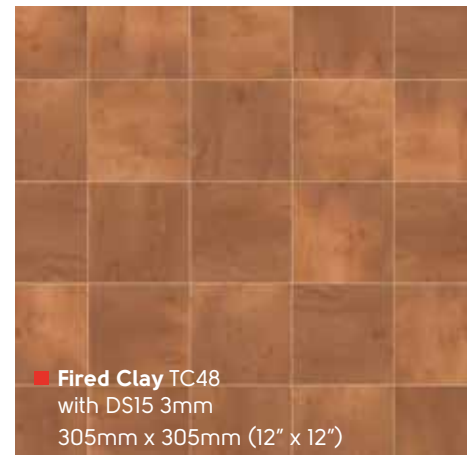

■ **Fired Clay TC48**  
with DS15 3mm  
305mm x 305mm (12" x 12")

# Knight Tile Mid Stone

Please see page 8 for size comparison guide

Find your nearest retailer at [www.karndean.com/FAR](http://www.karndean.com/FAR) or call 01386 820100







T100 with DS10 3mm design strip ▽

*Dark stone is a forgiving choice, especially in busy rooms like your kitchen*



T102 with DS02 3mm design strip and Windsor border ▽



■ **Jura T101**  
with DS14 3mm design strip  
305mm x 305mm (12" x 12")



■ **Ramsey T102**  
with DS14 3mm design strip  
305mm x 305mm (12" x 12")



■ **Cumbrian Stone ST14**  
with DS10 3mm design strip  
305mm x 457mm (12" x 18")



■ **Orkney T100**  
with DS14 3mm design strip  
305mm x 305mm (12" x 12")



■ **Onyx T88**  
with DS12 3mm design strip  
305mm x 305mm (12" x 12")



■ **Midnight Black T74**  
with DS12 3mm design strip  
305mm x 305mm (12" x 12")



# Knight Tile Dark Stone

Please see page 8 for size comparison guide

Find your nearest retailer at [www.karndean.com/FAR](http://www.karndean.com/FAR) or call 01386 820100

# Your guide to Design Strips...

To complete your look, add a design strip.  
Choose from a wide range of tones and textures available in **3, 5, 10, 30 and 76mm** (unless otherwise specified). Place these between tiles to create a natural grouting effect or to enhance the design of your floor.  
We have a wide range of strips, but they only work with certain products. Your retailer will be able to help you select the right strip for your chosen floor.

## Compatible with...



Design strips available for use with:  
Art Select, Da Vinci, and Van Gogh floors.



Cotswold SS6



Scandinavian Beech RP04



American Oak RP11



Indian Teak RP12



French Chestnut RP13



Australian Walnut RP41



Burnt Ginger VG5



Lime VG6



Midnight Oak HC06



Spring Oak RL01

Only available in 30mm bevelled strip



Dawn Oak HC01

Only available in 30mm bevelled strip

## Compatible with...



Design strips available for use with:  
Da Vinci, Opus, and Michelangelo floors.



Cotswold SS6



Utah REN34



Gold J86



Beechwood P504



Burnt Ash MP3



Golden Teak P702



Mahogany P802



Honey Beech P707



Midnight Oak HC06



Mercury J89



Atomic MLC08



Comet MLC07



Galician Quartz MS1

Only available in 10, 30, 76mm widths



Navarra Chalk MS2

Only available in 10, 30, 76mm widths



Neopolitan Brick MX93

We recommend only using this strip in 10, 30, and 76mm widths



■ **Blond Oak AP01** with P802 3mm and RL01 30mm design strips



■ **Santi Limestone LST05** with REN34 3mm design strip



■ **Walnut VGW87T** with DS07 5mm design strip



■ **Ignea WP313** with DS07 3mm design strip



## Compatible with...



These design strips available for use with all our floors. Available in 3, 5 and 10mm widths.



Vanilla DS01



Blond DS02



Honey DS03



Coffee DS04



Russet DS05



Chocolate DS06



Ebony DS07



Cocoa Cross Grain DS08



Carbon Cross Grain DS09

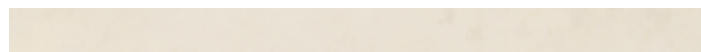

Chalk DS10



Concrete DS12



Sand DS13



Stone DS14



Clay DS15



Charcoal DS16



Silver DS17



Frost DS18



Kohl DS19

## Compatible with...



Grout strips are available in a range of six colours at 3mm and 5mm wide. For use with Da Vinci, Opus and Michelangelo floors.



Beige AF06



Ivory AF05



Taupe AF04



Brown AF02



Chestnut AF07



Black AF01

## Compatible with...



Metallic strips are available in a range of five colours. For use with Da Vinci, Opus and Michelangelo floors.



Silver



Gold



Blue



Copper



Purple

If you're looking for something completely bespoke, consider using the design service offered by your local retailer who can advise you on custom-made design strips.

# Decorative Wood Borders

Why not finish your floor with one of our decorative wood borders? To help you choose, we've made some suggestions below.

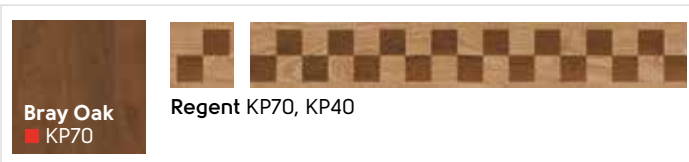
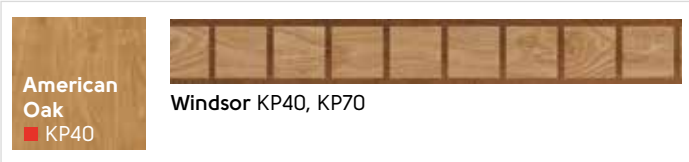
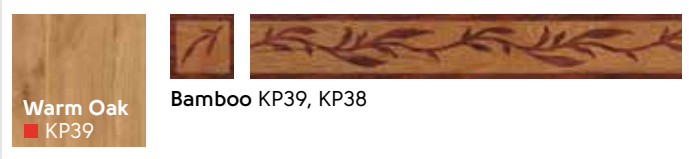
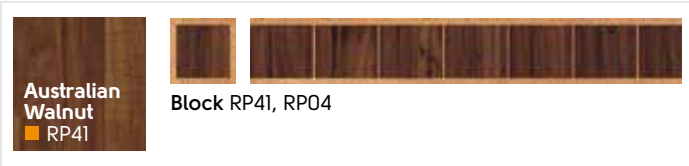

*Looking for a custom border to suit your floor?*

Your local retailer will offer you a design service to help you choose a style.





■ Warm Oak KP39 with Bamboo border KP38



# Decorative Stone Borders

Add interest to your floor with one of our decorative stone borders?  
To help you choose, we've made some suggestions below.

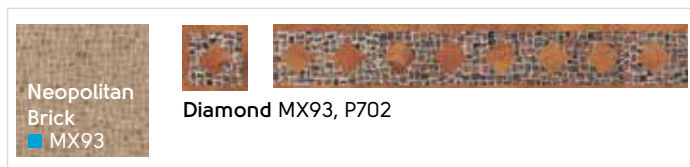
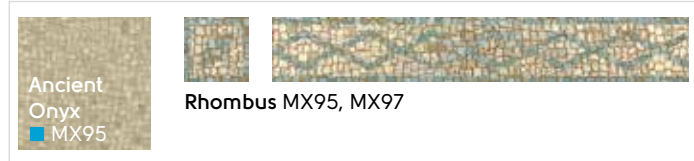

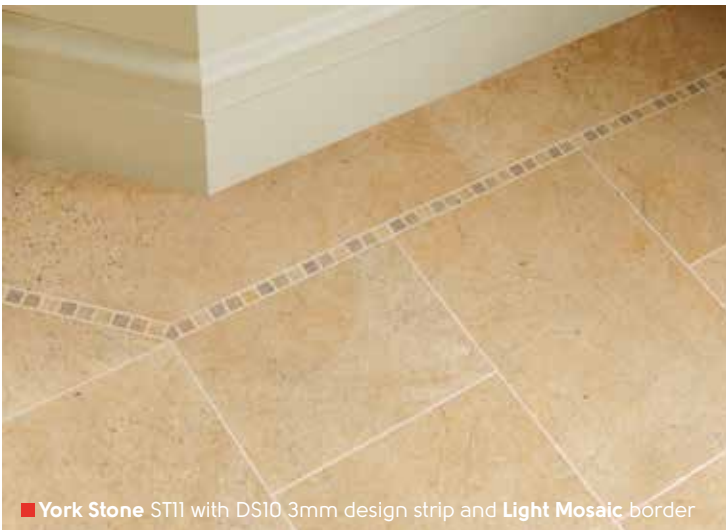
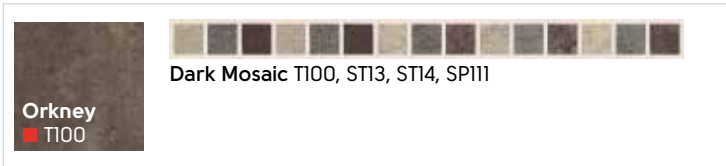
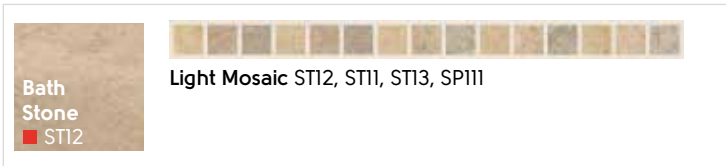



■ Portland Stone ST13 with DS10 3mm design strip and Light Mackintosh border



Features are 3ft wide  
as standard but can be  
scaled up or down

# Bespoke Features

## 1 Pick your favourite from our standard feature designs



Cartwheel with border  
KP39 | KP107



Cartwheel  
T100 | ST8



Celtic  
LST02 | LST04



Galaxy  
VG5-7 | RP11 | RP41



Dolphin  
MS97 | MX98



Sun  
MS97 | MX98



Star  
KP32 | KP40 | KP70 | KP107

## 2 Choose your own colours

We recommend you make the background colour of your chosen feature the same as your floor, then choose remaining colours to coordinate with the finishes in your room.

## 3 Decide on a size

You can select the size of your feature to fit perfectly into any shape of room. Our features come in a standard 3ft size, but can be scaled up or down to suit. Talk to your local retailer who can advise you on getting the right size for your space.

## Looking for a bespoke design?

If you're looking for something a little bit different, you can design your own unique feature. Take a sketch of your idea to your nearest retailer for help creating a truly bespoke floor for your home.









Karndean  
Designflooring

Karndean  
LooseLay

# What makes Karndean LooseLay special?

Karndean LooseLay is a new format of luxury vinyl flooring featuring a friction grip backing that holds the product in place.

Boasting the realistic designs and grain details customers expect from Karndean, LooseLay is available in large scale wood look planks and stone look tiles and can help you create a look that works in almost any space. What's more, it's easy to install and can be laid over most existing hard floors. Oh, and it's 100% recyclable!

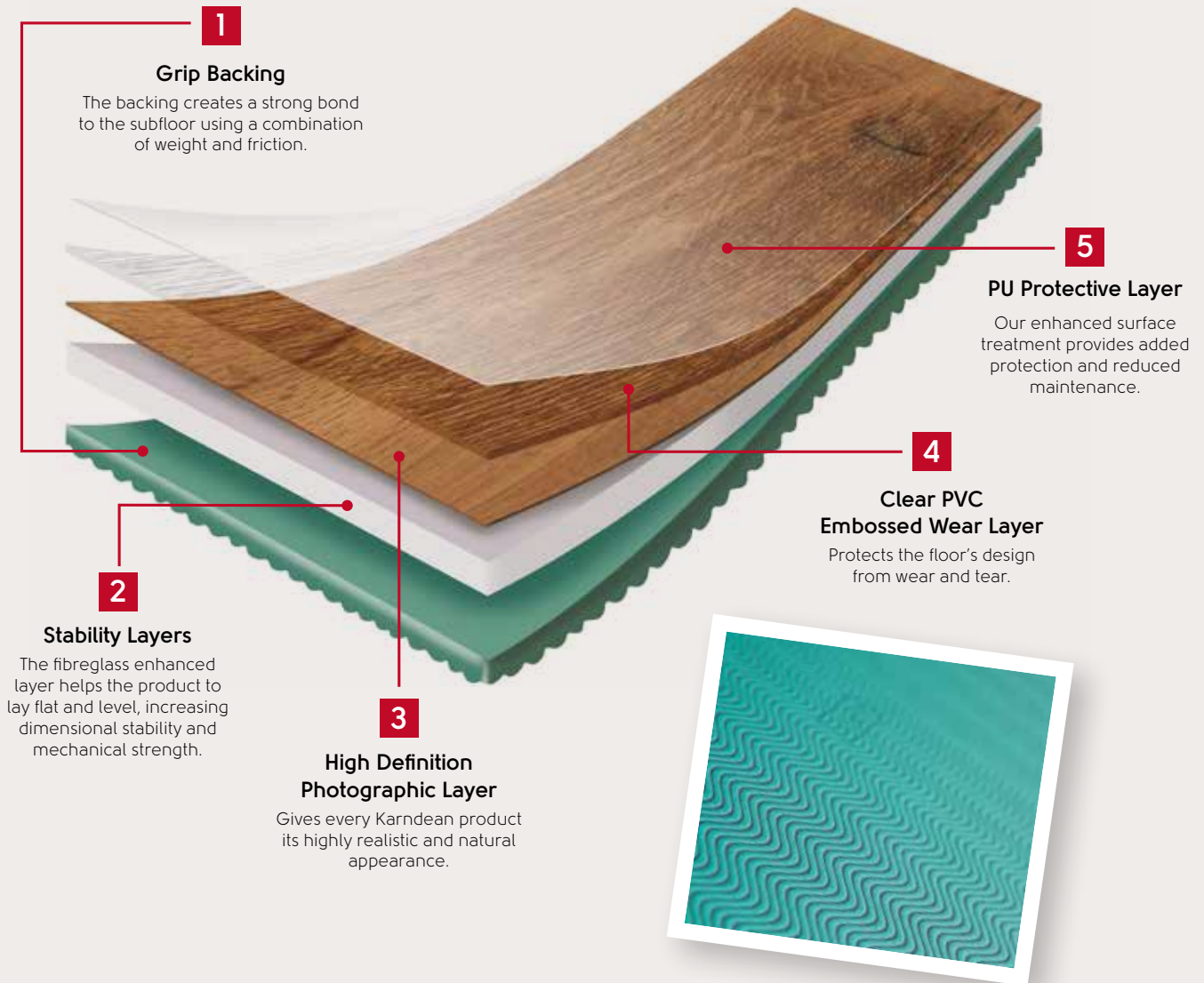

# Why Karndean LooseLay?



## Quick and easy to install

All you need is a sound, smooth, dry and dust free subfloor. **Karndean LooseLay** can be fitted over most existing hard floors.



## Compatible with underfloor heating

Up to 27°C



## Individually replaceable

Should you need to replace a piece, simply lift the damaged plank or tile and replace with a new one.

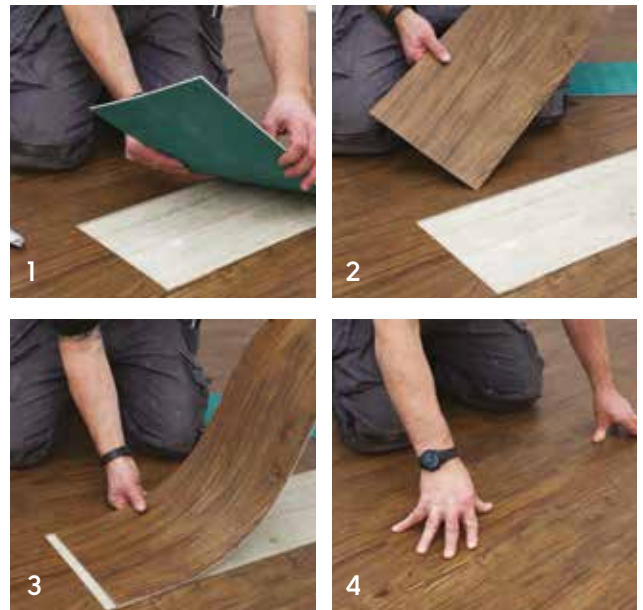

## Acoustic qualities

**Karndean LooseLay** is perfect for projects where you want to reduce noise levels in the room below, such as playrooms, bedrooms and garage/ loft conversions without the need for underlay.



## Comfortable underfoot

Our products are softer and warmer underfoot than natural wood and stone flooring. Additional cushioning in the backing helps make the product more comfortable underfoot.



## Realistic designs

Available in contemporary larger scale planks and tiles, **Karndean LooseLay** is available in a variety of colour tones and styles.



## Durable

**Karndean LooseLay** is extremely hardwearing. Unlike real wood and stone, it won't splinter, warp or crack.



## 100% recyclable



## Low maintenance

We use PU technology to ensure that there is no need to apply an additional surface treatment following installation.





△ LLP101



Easy and quick to change  
the look of your space



■ Country Oak LLP92

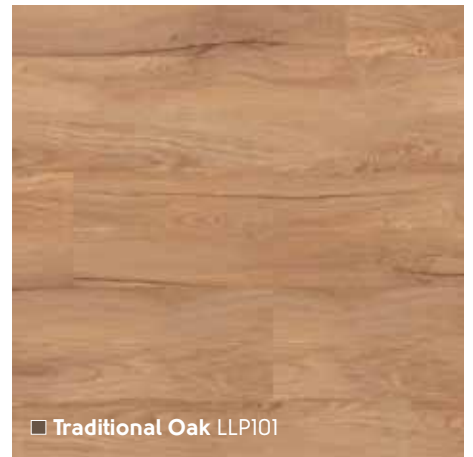

■ Traditional Oak LLP101

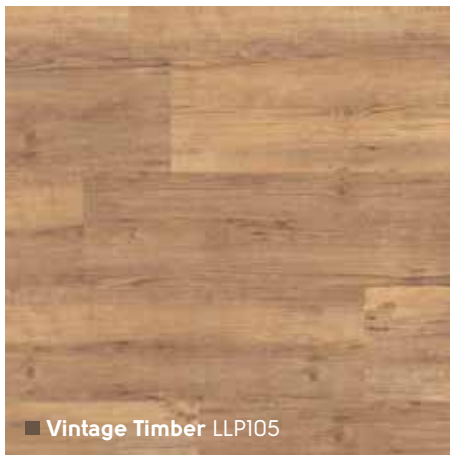

■ Vintage Timber LLP105

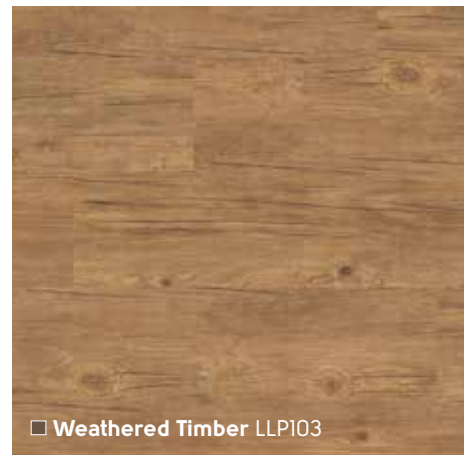

■ Weathered Timber LLP103

## Karndean LooseLay Series One Wood

1050mm x 250mm (41.3" x 9.85")

Find your nearest retailer at [www.karndean.com/FAR](http://www.karndean.com/FAR) or call 01386 820100

Enhanced  
acoustic  
benefits

LLP104 ▽



LLP104 ▽

□ Antique Timber LLP106



□ Heritage Oak LLP102

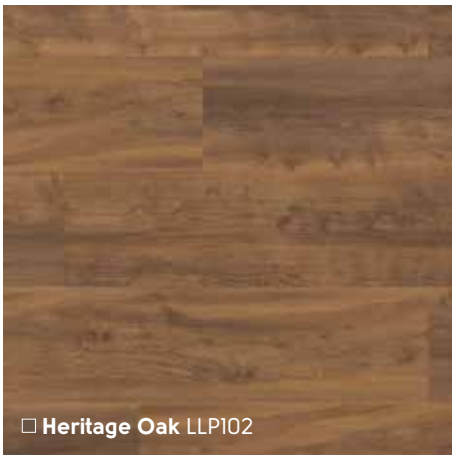

□ Rustic Timber LLP104

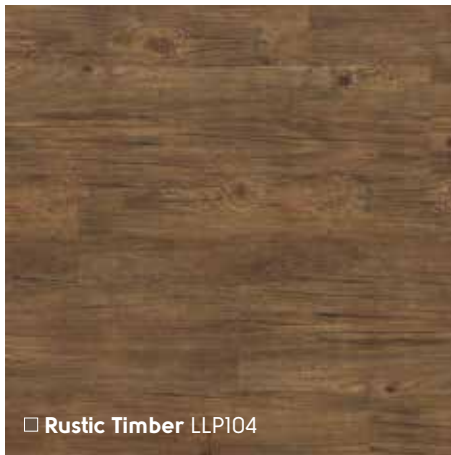

## Karndean LooseLay Series One Wood

1050mm x 250mm (41.3" x 9.85")

Find your nearest retailer at [www.karndean.com/FAR](http://www.karndean.com/FAR) or call 01386 820100







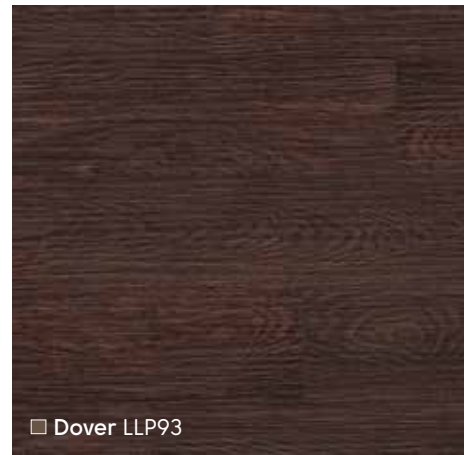
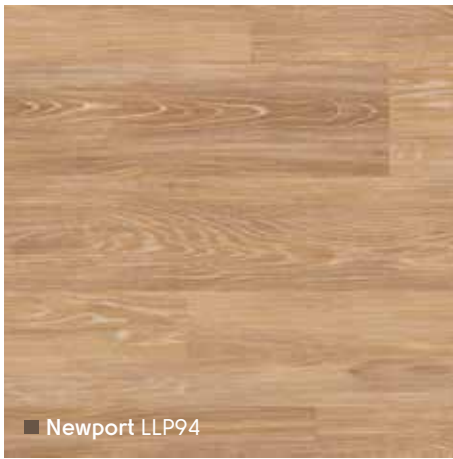
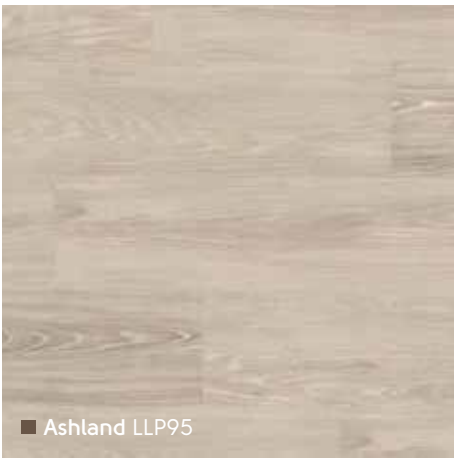

## Karndean LooseLay Series Two Wood

All Series Two woods feature a hand scraped finish. 1050mm x 250mm (41.3" x 9.85")

Find your nearest retailer at [www.karndean.com/FAR](http://www.karndean.com/FAR) or call 01386 820100

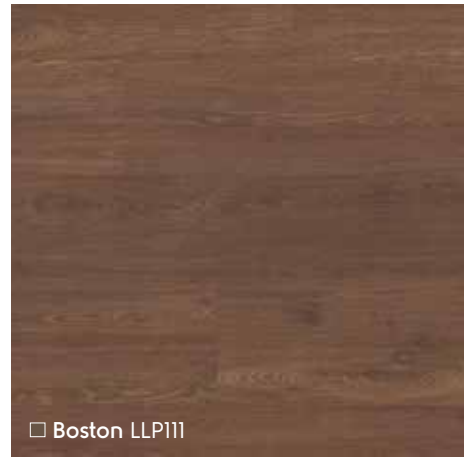
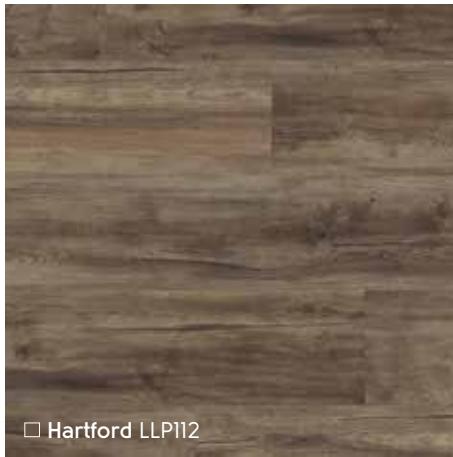
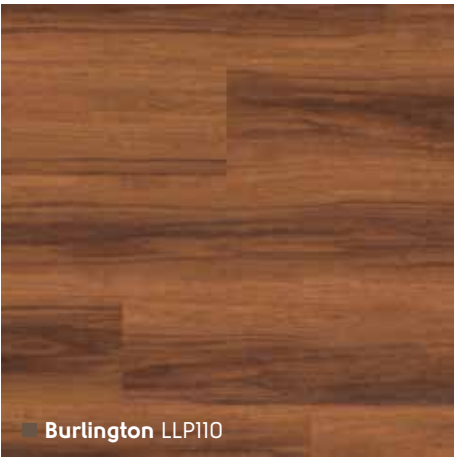
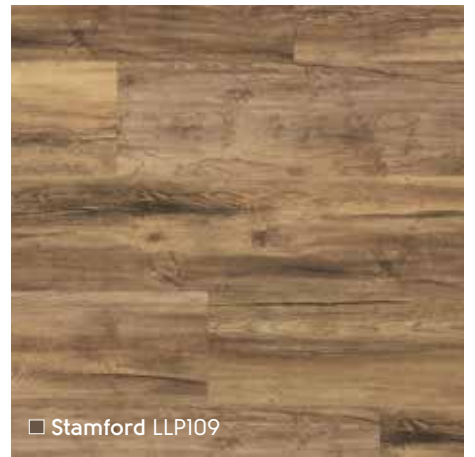
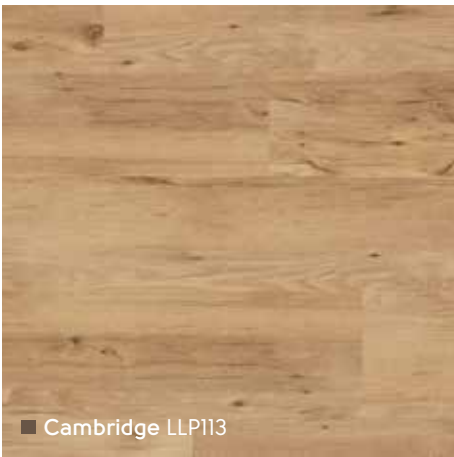

## Karndean LooseLay Series Three Wood

1050mm x 250mm (41.3" x 9.85")

Find your nearest retailer at [www.karndean.com/FAR](http://www.karndean.com/FAR) or call 01386 820100







LLT203 ▽



LLT202 ▽

Perfect for any room in your home



LLT200 ▽



■ Indiana LIT202



■ Colorado LIT201



□ Arizona LIT200



□ Madison LIT203

# Karndean LooseLay Series One Stone

500mm x 610mm (19.7" x 24")

Find your nearest retailer at [www.karndean.com/FAR](http://www.karndean.com/FAR) or call 01386 820100



Enhanced  
acoustic  
benefits

LLT206 ▽



□ Georgia LLT206



□ Texas LLT207

## Karndean LooseLay Series Two Stone

500mm x 610mm (19.7" x 24")

Find your nearest retailer at [www.karndean.com/FAR](http://www.karndean.com/FAR) or call 01386 820100











*Enhanced  
acoustic  
benefits*

LLT204



□ Pennsylvania LLT204



□ Nevada LLT205

# Karndean LooseLay Series Two Textile

500mm x 610mm (19.7" x 24")

Find your nearest retailer at [www.karndean.com/FAR](http://www.karndean.com/FAR) or call 01386 820100





 **PALIO CLIC**  
by **Karndean**

# Why Palio Clic?

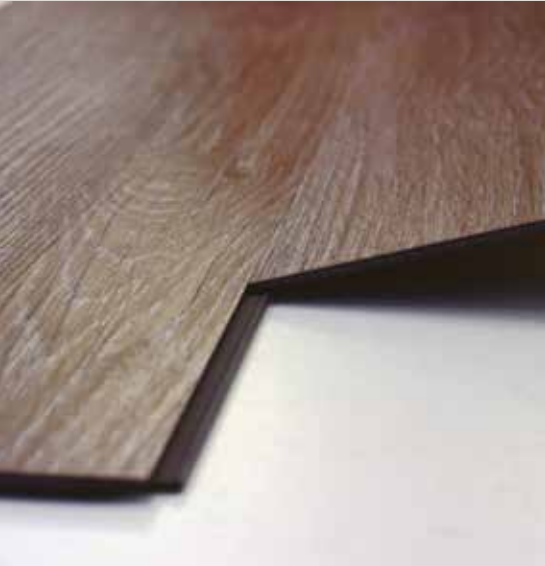

**Palio Clic by Karndean is a new type of luxury vinyl flooring with a patented click-locking system. Designed for quick and easy installation, with Palio Clic you can achieve an authentic and luxurious feel in your space in no time at all.**

With eight intricate wood and four classic stone designs, each plank and tile boasts realistic textures and grain details with a hard-wearing and easy to clean wear layer.

The eight wood look planks are available in a popular large plank format while the four stone designs are available as a contemporary, rectangular tile format.



## Click-locking system

Simply click your planks or tiles into place with our patented locking system.



## Quick and easy to install

All you need is a sound, smooth, dry and dust free subfloor to start laying immediately. You can find an easy to follow installation guide on our website.



## No need for adhesive

Our patented locking system means there's no need for adhesive and minimal preparation time is required.



## Realistic appearance

The authentic designs and structured surfaces of each plank and tile imitate nature to perfection.



## Suitable for renovation

At just 4.5mm thick, it is ideal for laying over most existing hard floor coverings.



## Durable

With a 0.4mm wear layer Palio Clic is very hard wearing and ideal for use in the home and public areas with light to medium traffic.



## Easy to clean

Mop up spills as soon as possible, using a pH neutral cleaner, to reduce the risk of staining.



## Warm Underfoot

Our products are softer and warmer underfoot than natural wood and stone flooring.



## Underfloor heating

Compatible with underfloor heating up to 27°C.



## 100% Recyclable







CP4503 ▽



□ Sorano CP4508



□ Arezzo CP4503

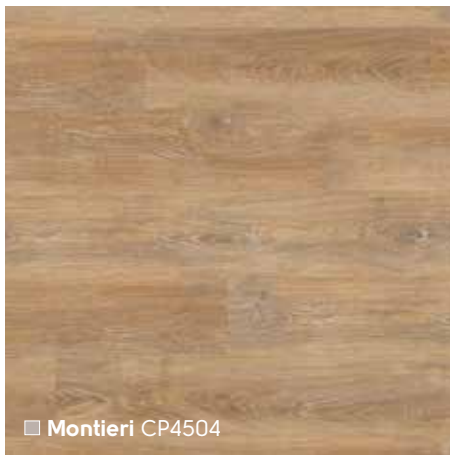

□ Montieri CP4504



□ Crespina CP4505

## Pailo Clic by Karndean Wood

1220mm x 179mm (48" x 7")

Find your nearest retailer at [www.karndean.com/FAR](http://www.karndean.com/FAR) or call 01386 820100



CP4507 Δ



■ Bolsena CP4507



■ Lucca CP4509



CP4509 Δ

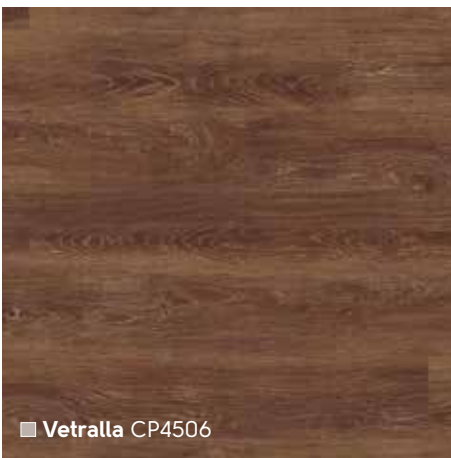

■ Vetralla CP4506

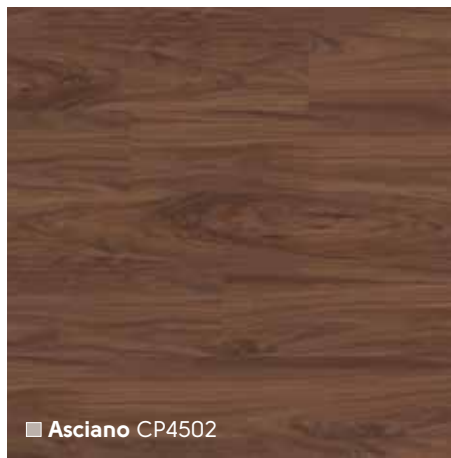

■ Asciano CP4502

## Pailo Clic by Karndean Wood

1220mm x 179mm (48" x 7")

Find your nearest retailer at [www.karndean.com/FAR](http://www.karndean.com/FAR) or call 01386 820100









CT4303 ▽



CT4304 ▽



□ **Murlo** CT4302



□ **Pienza** CT4303



□ **Volterra** CT4301



□ **Cetona** CT4304

## Pailo Clic by Karndean Stone

600mm x 307mm (24" x 12")

Find your nearest retailer at [www.karndean.com/FAR](http://www.karndean.com/FAR) or call 01386 820100



Our ranges  
at a glance...

## Art Select at a glance

Parquet 228mm x 76mm (9" x 3")



■ Blond Oak AP01



■ Morning Oak AP06



■ Auburn Oak AP02



■ Spanish Cherry AP05

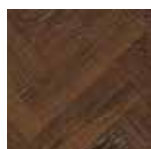

■ Sundown Oak AP04

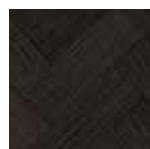

■ Black Oak AP03



■ Russet Oak AP31

406mm x 406mm (16" x 16")

Oak Royale 1219mm x 178mm (48" x 7")



■ Spring Oak RL01



■ Summer Oak RL02



■ Autumn Oak RL03



■ Winter Oak RL04



■ Spanish Cherry RL05



■ Santina Cherry RL07

Oak Premier 915mm x 152mm (36" x 6")



■ Dawn Oak HC01



■ Morning Oak HC02



■ Dusk Oak HC03



■ Sundown Oak HC04



■ Evening Oak HC05



■ Midnight Oak HC06

Handcrafted 915mm x 152mm (36" x 6")



■ Hickory Paprika EW01



■ Hickory Nutmeg EW03



■ Hickory Peppercorn EW02

## Da Vinci at a glance

915mm x 76mm (36" x 3")



■ American Oak RP11

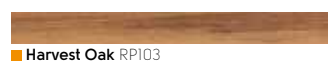

■ Harvest Oak RP103

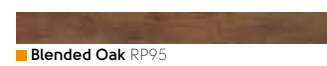

■ Blended Oak RP95

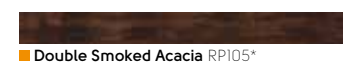

■ Double Smoked Acacia RP105\*



■ Fresco Light Oak RP90



■ Swedish Birch RP75



■ Single Smoked Acacia RP104\*

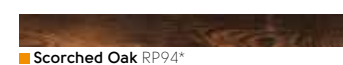

■ Scorched Oak RP94\*



■ English Elm RP51



■ Kenyan Tigerwood RP73

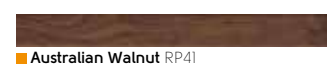

■ Australian Walnut RP41



■ Coastal Driftwood RP100\*



■ Limed Linen Oak RP98\*



■ Lorenzo Warm Oak RP91



■ Materia Dark Oak RP67



■ Limed Silk Oak RP96\*



■ Natural Oak RP102



■ Limed Jute Oak RP97\*



■ Beach Driftwood RP101\*



■ Limed Cotton Oak RP99\*

\*Please note: as a feature of the design, these products incorporate a high color variation between individual planks.

# Van Gogh at a glance

1219mm x 178mm (48" x 7")



■ White Washed Oak VGW80T



■ Distressed Oak VGW82T



■ Antique Karri VGW39T



■ Macrocapra VGW50T



■ Country Oak VGW81T



■ Reclaimed Maple VGW71T



■ Birch VGW84T



■ Frosted Birch VGW83T



■ Wellington Oak VGW53T



■ French Oak VGW85T



■ Auckland Oak VGW52T



■ Vintage Pine VGW76T



■ Lancewood VGW44T



■ Smoked Oak VGW70T



■ Brushed Oak VGW88T



■ Classic Oak VGW86T



■ Christchurch Oak VGW54T



■ Ebony VGW89T



■ Burnt Ginger VG5-7



■ Aged Kauri VGW51T



■ Bracken VG1-7



■ Walnut VGW87T

## Opus at a glance

915mm x 152mm (36" x 6")



■ Grano WP311



■ Palleo WP312



■ Cera WP314



■ Aurum WP315



■ Ignea WP313



■ Rubra WP316



■ Atra WP317



■ Carbo WP318

1219mm x 228mm (48" x 9")



■ Niveus WP411



■ Primo WP412



■ Magna WP413



■ Argen WP414

915mm x 102mm (36" x 4")



■ Weathered Elm REN113

## Knight Tile at a glance

915mm x 102mm (36" x 4")



■ Arctic Driftwood KP51



■ Pitch Pine KP45



■ Sycamore KP32



■ Sienna KP107



■ Shannon Oak KP68



■ Edwardian Oak KP92



■ Pear KP55



■ Tudor Oak KP38



■ American Oak KP40



■ Native Koa KP93



■ Warm Oak KP39



■ Caribbean Driftwood KP52



■ Victorian Oak KP91



■ Bray Oak KP70



■ Aran Oak KP67

915mm x 152mm (36" x 6")



■ White Painted Oak KP105



■ Mid Limed Oak KP96



■ Pale Limed Oak KP94



■ Mid Worn Oak KP103



■ Lime Washed Oak KP99



■ Mid Brushed Oak KP102



■ Classic Limed Oak KP97



■ Aged Oak KP98

# Art Select at a glance

**Limestone** 915mm x 915mm (36" x 36") Random Panel\*



■ Jersey LM01

■ Guernsey LM02



■ Alderney LM03

■ Herm LM20

**Welsh Slates** 915mm x 915mm (36" x 36") Random Panel\*



■ Oakeley LM11

■ Corris LM12

\*Made up in a pre-assembled panel of 9 assorted tiles with design strip and offsetting tiles to create a random look.

**Travertine** 457mm x 610mm (18" x 24")



■ Washburn LM07

■ Caldera LM08

■ Gallatin LM09

**Travertine** 152mm (6") x FreeLengths\*\*



■ Washburn LM17

■ Caldera LM18

■ Gallatin LM19

\*\*These stones are 6" wide in varying lengths.

**Ashford Marble** 915mm x 915mm (36" x 36") Random Panel\*



■ Ashford LM10

**Italian Marbles** 406mm x 406mm (16" x 16")

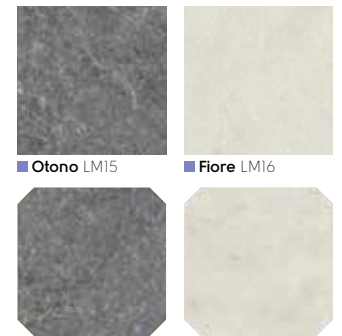

■ Otono LM15

■ Fiore LM16

■ supplied with LM16 Key Squares

■ supplied with LM15 Key Squares

■ Otono LM15-CLIP

■ Fiore LM16-CLIP

**Welsh Slates** 457mm x 610mm (18" x 24")



■ Oakeley LM21

**Parliament Slates** 457mm x 610mm (18" x 24")



■ Melbourne LM05



■ Corris LM22



■ Canberra LM06

# Da Vinci at a glance

406mm x 406mm (16" x 16")



■ Sienna Limestone LST02

■ Piazza Limestone LST03

■ Spirito Limestone LST04

■ Mocha CK24

■ Santi Limestone LST05

■ Graphite CC06

■ Noir CK25



## Michelangelo at a glance

305mm x 305mm (12" x 12")



406mm x 406mm (16" x 16")

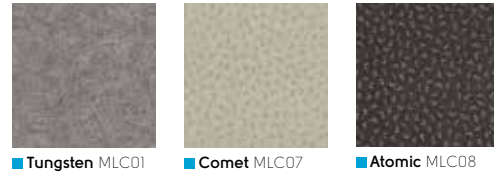

\*\*\*Supplied with 76mm (3") mini pebble design strips and key squares

## Opus at a glance

915mm x 915mm (36" x 36") Random Panel\*



■ Atlantic Slate REN21

457mm x 457mm (18" x 18")



305mm x 457mm (12" x 18")



457mm x 610mm (18" x 24")



## Knight Tile at a glance

305mm x 305mm (12" x 12")

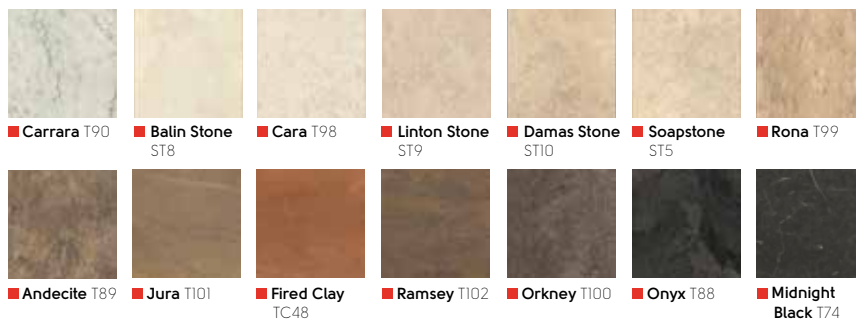

305mm x 457mm (12" x 18")

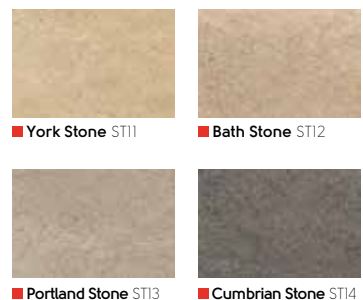

# Karndean LooseLay Wood at a glance

## Series One

1050mm x 250mm (41.3" x 9.85")



■ Country Oak LLP92



■ Antique Timber LLP106



■ Traditional Oak LLP101



■ Heritage Oak LLP102



■ Vintage Timber LLP105



■ Rustic Timber LLP104



■ Weathered Timber LLP103

## Series Two

1050mm x 250mm (41.3" x 9.85")



■ Ashland LLP95



■ Winchester LLP97



■ Newport LLP94



■ Salem LLP96



■ Hudson LLP99



■ Dover LLP93

## Series Three

1050mm x 250mm (41.3" x 9.85")



■ Cambridge LLP113



■ Burlington LLP110



■ Providence LLP108



■ Hartford LLP112



■ Stamford LLP109



■ Boston LLP111

# Karndean LooseLay Stone at a glance

## Series One

500mm x 610mm (19.7" x 24")



■ Indiana LLT202



■ Colorado LLT201



■ Arizona LLT200



■ Madison LLT203

## Series Two

500mm x 610mm (19.7" x 24")



■ Georgia LLT206



■ Texas LLT207

# Karndean LooseLay Textile at a glance

## Series Two

500mm x 610mm (19.7" x 24")



■ Pennsylvania LLT204



■ Nevada LLT205

## Palio Clic by Karndean Wood at a glance

1220mm x 179mm (48" x 7")



**Sorano** CP4508



**Arezzo** CP4503



**Montieri** CP4504



**Bolsena** CP4507



**Crespina** CP4505



**Vetralla** CP4506



**Asciano** CP4502



**Lucca** CP4509

## Palio Clic by Karndean Stone at a glance

600mm x 307mm (24" x 12")



**Murlo** CT4302



**Pienza** CT4303



**Volterra** CT4301



**Cetona** CT4304

# Cleaning and maintaining your Karndean floor

Karndean Designflooring is hardwearing and easy to look after. Our enhanced surface treatment helps protect against everyday wear, spills and scuffs. This makes it easier and more environmentally friendly to clean and maintain, giving you peace of mind that your Karndean floor will look great for years to come.

We have a dedicated section on the website with videos which explain how best to look after your Karndean floor and covers lots of frequently asked questions from our customers.

We also have our own Floor Care Kits that you can order from your local retailers including everything you need for a simple cleaning routine.



## Inside your Floor Care Kit

Regular cleaning with a pH neutral cleaner such as Karndean Clean will help keep your floor at its best.

After time you may want to treat your floor to some extra care. We recommend every six to twelve months, depending on wear, that you strip and refresh your floor using Karndean Remove and Karndean Refresh, to further enhance its look and durability.



- 1 Karndean Clean 750ml
- 2 Karndean Remove 750ml
- 3 Karndean Refresh 750ml
- 4 Floor Protector Pack
- 5 Refresh Pad (soft/white)
- 6 Remove Pad (coarse/white)
- 7 Applicator
- 8 Floor Care Guide



# Things to think about...

Our expert staff are here to help you design your floor. Pop in to see your local retailer or visit our showroom in Evesham where you can see over 500m<sup>2</sup> of Karndean Designflooring!

## Helpful hints and tips to help you choose your Karndean floor.

1. Which room in your home do you need flooring for?
2. What style suits your home - classic, contemporary, traditional?
3. Choose your effect - Wood or Stone?
4. What colours will suit your space?  
Circle the ones you like on the 'at a glance' pages 148-155. Use pictures, cuttings or swatches of colours and designs you like to help you choose.
5. Have you thought about finishing touches? For decorative borders or strips, see pages 108-119.

Useful notes

Draw a sketch of the shape of your room with rough measurements to take to your retailer. They will visit your home as part of the service, to take accurate measurements and give expert advice.

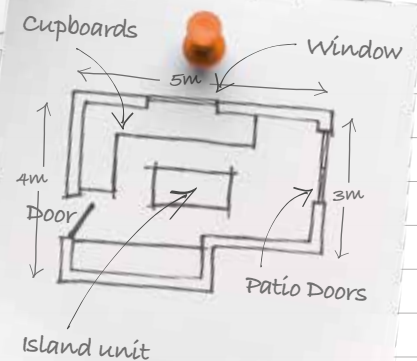



Visit us online at [www.karndean.com](http://www.karndean.com)  
where you can:

## Find your nearest recommended retailer

Use our online search facility to find your nearest **Karndean Designflooring** recommended retailer. Leave your details for a retailer to contact you for a free measure and quote.



## Order samples

If you need some extra help selecting the best colour for your room, why not order some colour chips? These are small samples designed to help you pick which product is right for you.



## Try our Floorstyle tool





We have developed a great tool which allows you to pick a room and see what different floors will look like. It's really easy to use and will allow you to create your perfect Designflooring combination.



## Sign up for our e-newsletter

We'd love to keep in touch with you. To receive our email communications sign up online today at [www.karndean.com](http://www.karndean.com)

## Keep up-to-date with us:

-  Follow us on Twitter [@karndeanfloors](https://twitter.com/karndeanfloors)
-  Like us on Facebook [karndeandesignflooring](https://www.facebook.com/karndeandesignflooring)
-  Follow our boards on Pinterest [karndeanfloors](https://www.pinterest.com/karndeanfloors)
-  For interior ideas follow us on Houzz [karndeandesignflooring](https://www.houzz.com/profile/karndeandesignflooring)
-  See what we've been up to in our blog [www.karndeanblog.com](http://www.karndeanblog.com)



## Our new App lets you view any Designflooring floor in your own home

With so many products to choose from, it can be difficult to decide which colours and formats you like. We've created an augmented reality app for iPad and iPhone which allows you to project any of our products onto your floor at home - without even leaving the house!

 Search for 'Karndean' in the App Store.

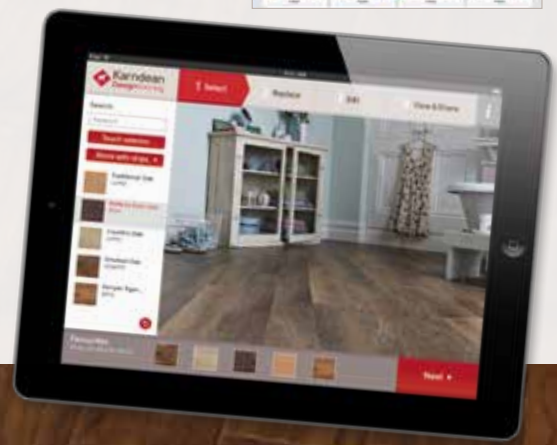



Visit our showroom in Evesham...



Based at our headquarters in the beautiful Vale of Evesham, we always have the latest products on display, with over 500m<sup>2</sup> of ideas and designs to inspire you.

As well as seeing the full range of **Karndean Designflooring**, you can speak to our trained advisors, use our design tables to try out your design ideas and take away full sized samples with you. We even have a children's play area if you want to bring them along on your visit.

#### Opening times:

Monday - Friday  
9am - 5.30pm

Saturday  
9am - 5.00pm

Sundays and Bank Holidays  
10am - 4pm

#### The showroom will be closed:

Easter Sunday  
Christmas Day  
Boxing Day  
New Year's Day



## Contact us...

**Karndean Designflooring**  
Crab Apple Way  
Evesham  
Worcestershire  
WR11 1GP

Call us on:  
**01386 820100**

Email us:  
**info@karndean.co.uk**

**www.karndean.com/contact**

Calls may be recorded for training and quality purposes.

### Colour & Pattern Reproduction

We are careful to make sure our brochures are accurate and printed to very high standards, but photography and printing cannot always create a perfect representation of our products. For this reason we strongly recommend that you look at a sample of any product you are considering before placing your order.

All of our products are inspired by things we have seen in the natural world and just like variation in colour and detail is part of the beauty of nature, it is also a feature of some of our designs. This means that with some of our products you will see natural variation when your floor is laid. If in doubt, ask your retailer to show you a larger sample of the product.

We love developing new ideas and improving our existing designs. Part of our policy of continuous improvement means that we may add, change or withdraw products from our ranges. We hate to disappoint and will always try to work with you to find an alternative design that you love so much.

**Karndean Designflooring** owns all their designs and are protected by copyright.

Use our virtual  
floor fitting app to:

Help you choose the  
perfect Karndean floor  
for your room

Change the direction that  
the floor is laid

Save and share your  
favourites



Karndean  
Designflooring

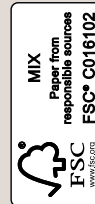

View a Karndean floor  
in your home today:

- Download our virtual floor fitting app to your iPhone or iPad.  
 Search 'Karndean' in the App Store.
- Follow the app's on-screen prompts and you'll be on your way to viewing our full catalogue of floors in your home today. You can also share your favourites with friends and family by email or on Facebook and Twitter.